



RADIO'S LIVEST MAGAZINE

Special
BEGINNER'S
Number

Radio-Craft

HUGO GERNSBACK
Editor

25 Cents
in United States
and Canada

RADIO QUESTIONS

RADIO QUESTIONS



March 36

Crystal Sets for the Beginner—Making a Midget 5-Meter Radio Station
A "Free-Reference-Point" R and C Analyzer—Recordings on Iron Wire



SUPREME INSTRUMENTS

Approved for

F.H.A. LOANS



SUPREME 385 AUTO-MATIC LABORATORY MODEL **\$77⁹⁵**



SUPREME 89 DeLUXE TUBE TESTER LABO-RATORY MODEL **\$45⁹⁵**

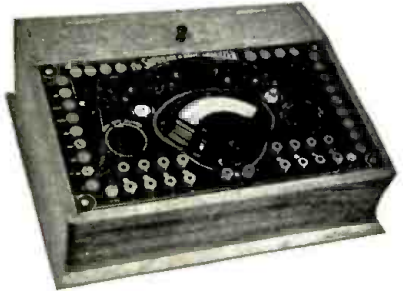

SUPREME 339 DeLUXE ANALYZER. LABO-RATORY MODEL **\$39⁹⁵**



SUPREME 189 SIGNAL GENERATOR. LABO-RATORY MODEL **\$36⁹⁵**

Let Uncle Sam equip YOUR shop NOW with the New Supreme Laboratory models you need, at no more cost than your telephone.

No Down Payment. As Long as 18 months to pay. Present FHA act expires in April. See your jobber NOW.

Now every serviceman can modernize his testing facilities with new time-saving, money-making Supreme equipment—WITHOUT PAYING A CENT DOWN. And pay only a fraction each month of the new business and profits this equipment will make possible.

Yes, Supreme has arranged with Uncle Sam to extend the provisions of FHA loans to the purchase of the new Supreme laboratory models pictured to the left. Your jobber will welcome your order on this business—will make arrangements, without red tape, for handling with his bank or directly with Supreme. It's incredibly easy now to have Supreme equipment.

Think of it as long as 18 months to pay, and only the nominal interest prescribed by FHA. Now you can completely equip your laboratory with the last word in testing equipment, at a monthly cost less than rent for one high grade piece of equipment.

FHA EXPIRES APRIL, 1936

Act quickly. See your jobber now. The present FHA act expires in April, 1936 is the serviceman's year. A opportunity—get your share of those extra service calls resulting from presidential radio-campaigning. Write us direct for any information on FHA loans with which your jobber cannot supply you.

SUPREME INSTRUMENTS CORPORATION
SUPREME BLDG. GREENWOOD, MISS., U.S.A.

Export Dept.: Associated Exporters Co., 145 W. 45th St., New York City, N. Y. Cable Address: LCPREMI, N. Y.

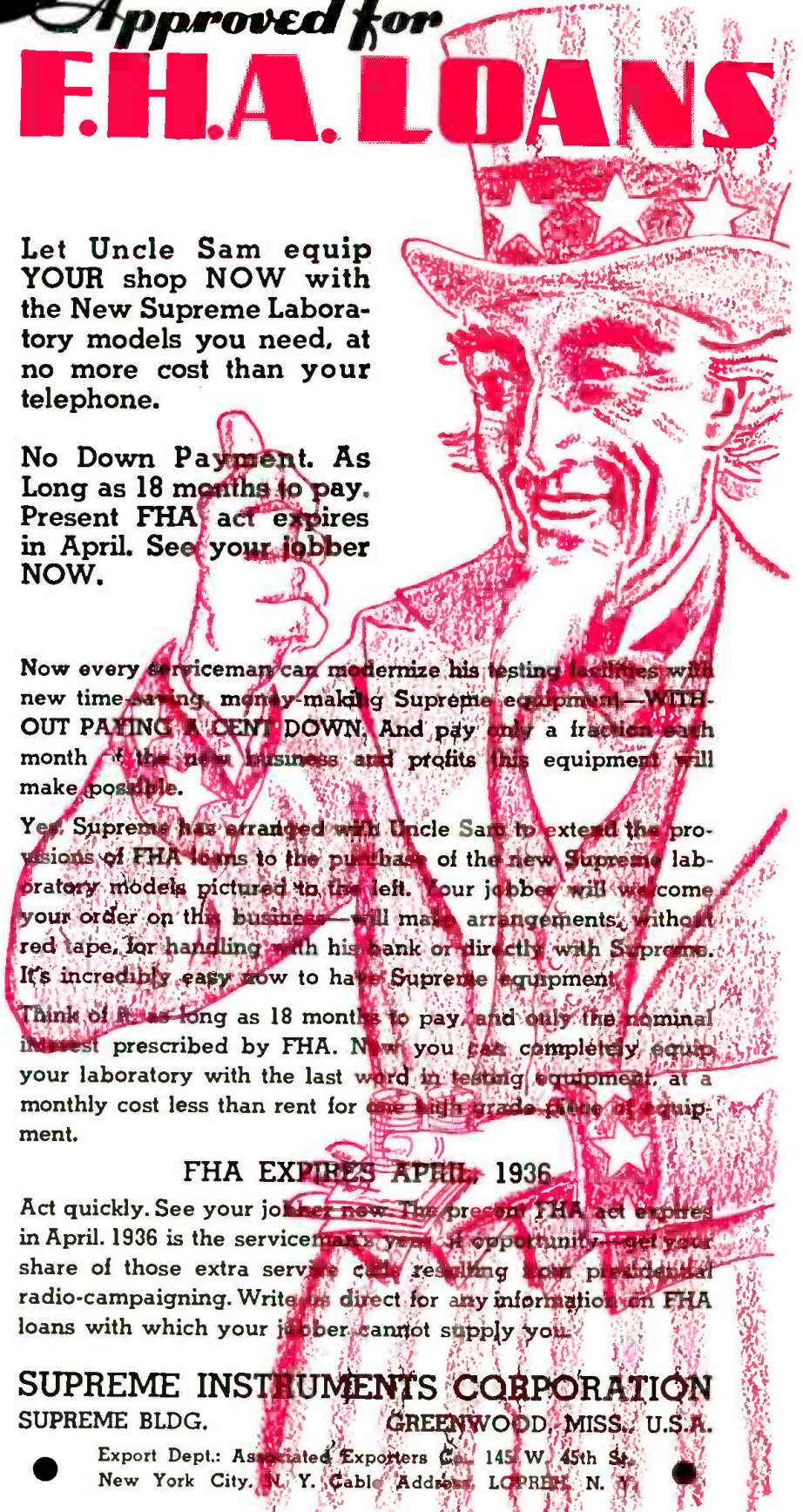



STUDENTS BUSY AT WORK IN LARGE COYNE SHOPS

Learn RADIO

SEND TODAY FOR DETAILS OF MY Pay-Tuition-after-Graduation Plan!

Train for Radio in 90 days, right here in the big Coyne Shops — not by correspondence — but on real Radio, Sound and Television equipment. Mail the coupon below. If you are short of money I'll send you all details of my finance plan and consider your application. If accepted, you won't have to start paying tuition back until five months from the date you start school, and then you'll have over a year to complete your payments.

Tremendous Developments Ahead in Radio and Television!

HERE is YOUR opportunity to cash in. Every day brings news of new developments in every branch of Radio and Television, with more opportunities, more jobs, and a greater future for the trained man than ever before. I consider the fellow who is ambitious enough to want to get ahead by taking my Training, worthy of my help. MAIL THE COUPON BELOW and you can prove to me that you are willing to spend just 12 weeks in the Coyne Training Shops learning Radio. Then, I'll tell you about my finance plan which has enabled many to get complete Training and pay tuition back later.

Learn By Doing In 90 Days

I don't care whether you are 16 or 45. It makes no difference to me if you don't know an oscillator from a spark coil. You don't need any previous experience or advanced education to master my Shop Training. Don't let lack of money hold you back from getting all details of my amazing plan.

MANY EARN While LEARNING

If you need part-time work to help pay your living expenses and will tell us your problems we may be able to help you as we have thousands of others. Then, in 12 brief weeks, in the great Training shops of Coyne, you will learn on a wide variety of modern, up-to-date A. C. Super-heterodyne sets, oscillators, analyzers and test instruments. Prepare for Amateur Broadcast, or Telegraph Radio Operator's License and to know all code and Dept. of Commerce rules for a government License Examination.

TRAINING

By Actual Work

No dull books . . . you get individual training . . . real actual work with only the theory you will need. Building real radio sets,



Auto Radio Instruction Prepare For Jobs Like These

Here are a few of hundreds of positions in the Radio field. My free employment bureau gives you life-time employment service.

- AIRCRAFT RADIO OPERATOR
- SHIP RADIO OPERATOR
- RADIO SERVICING
- PUBLIC ADDRESS SYSTEMS
- BROADCAST STATION OPERATOR
- TALKING PICTURE STUDIOS
- TELEVISION LABORATORY MAN

doing radio wiring and testing, trouble-shooting, repairing and servicing. That's a glimpse of how we help to make you a Radio expert, and fit you to qualify for jobs leading to the biggest pay.

Jobs - Pay - Future

"I got my present job two days after graduation, at shorter hours, and wages increased 60% over my old job," reports Arne Wiklem of Minnesota. "I have my own shop, own a real car and make fine money in the radio business," writes E. Allen of Montana, "All this is possible because I came to Coyne." And I could go on quoting from hundreds of letters of successful Coyne Trained men. What they have done, you should be able to do.

Electric Refrigeration Air Conditioning

Right now I'm including my new Electric Refrigeration and Air Conditioning course at no extra cost.

GET THE FACTS

Coyne is your one great chance to get into Radio. This school is 36 years old—Coyne training is tested—proven beyond all doubt—endorsed by many large concerns. You can find out everything absolutely free. Simply mail the coupon and let me send you the big, free Coyne Book with photographs . . . facts . . . jobs . . . salaries . . . opportunities. Tells you how many earn expenses while training and how we assist our graduates in the field. This does not obligate you. So act at once.

MAIL Coupon Today for FREE BOOK!

H. C. Lewis



Home of Coyne Shops

This is our fireproof modern Building wherein is installed thousands of dollars' worth of Radio equipment of all kinds. Every comfort and convenience has been arranged to make you happy and contented during your Training.

H. C. LEWIS, President Coyne Radio & Electrical School 500 S. Paulina St. Dept. 36-8H, Chicago

Dear Mr. Lewis: Without obligation send me your big free catalog and all details; also tell me all about your "Pay-Tuition-After-Graduation" Plan.

Name.....
 Address.....
 City.....State.....

COYNE H. C. LEWIS, President **Founded 1899**
RADIO & ELECTRICAL SCHOOL
500 South Paulina Street Dept. 36-8H Chicago, Ill.

Please Say That You Saw It in RADIO-CRAFT



CONTENTS—MARCH 1936, ISSUE

Volume VII

Number 9

Editorial: Famous Radio Beginners.....Hugo Gernsback	517
The Radio Month in Review.....	518
The "Radio" Beginner.....R. D. Washburne	520
A Beginner's Set Using the New "F.C.T." Detection System.....Jean Dieuzy	521
Radio Pictorial.....	522
New Tube Developments.....	524
Instrument Needs of the Beginner in Servicing.....	524
Making a 5-Meter Portable Radio Station.....H. G. McEntee	525
Making a Good Crystal Set for 65c....Frank F. Januss	526
1-Meter Superhet. Servicing Procedure.....F. W. D. Pearson	526
Cornerstones of Radio—Ohm's Law..E. W. Slope Part I	527
How to Make a "Free-Reference-Point" Resistance-Capacity Analyzer.....W. C. Bellheimer	528
Useful Radio Circuits.....	529
"Pull-Push" Moisture-Proofing for Transformers.....C. E. DeHorn	530
A Beginner's Sectional Test Panel.....E. J. Madden	530
A "Magic Eye" Leakage Tester.....C. T. Nicholson	531
The Listening Post for All-Wave DX-ers.....Charles A. Morrison	532
An All-Wave Adapter for Old Sets.....	533
Higher Fidelity for Everyone.....Archibald J. Bell	533
Making a 12-Tube High-Fidelity Broadcast Receiver, Part II.....M. H. Gernsback	534
New Hints on Eliminating Interference.....	535

HUGO GERNSBACK, Editor-in-Chief
 C. W. PALMER Associate Editor
 H. G. McENTEE Associate Editor
 R. D. WASHBURNE, Technical Editor

What the P.A. Beginner Should Know..Hubert L. Shortt	535
RADIO-CRAFT'S Information Bureau.....	536
Sound Recording on Magnetic Materials.....Wilhelm E. Schrage	537
Short-Cuts in Radio.....	538
Directed Sound—A New Method of "Individual" Reception.....Arthur T. Cahill	539
A Pocket-Size Beginner's Crystal Set..Stanley Johnson	540
2-Dozen Ideas for Your Service Shop.....Alfred A. Ghirardi	540
International Radio Review.....	541
The Latest Radio Equipment.....	542

RADIO SERVICE DATA SHEETS:

No. 157—Crosley 425 (Travo) 4-Tube Portable A.C.-D.C. Superhet.;	
Crosley 515 (Fiver) 5-Tube 2-Band Superhet.;	
Crosley 555 (A.F.M.) 5-Tube 2-Band Superhet.....	544
No. 158—Fairbanks-Morse Model 81 2-Band 8-Tube Chassis;	
Firestone—Stewart-Warner Model R-1332 5-Tube Auto Radio Set.....	546
No. 159—International Model 90 4-Tube Receiver and Power Supply;	
Belmont 578 Series A, A.C. Superheterodyne.....	547
ORSMA Members' Forum.....	545
Operating Notes.....	548
Technicians' Data Service.....	551
Does Lightning Go Up or Down?.....W. W. Lewis	569
Book Review.....	575

(ANNUAL) ELECTRONICS NUMBER

This time last year we introduced the first special Electronics Number of RADIO-CRAFT in which were featured the newest data concerning various electronic devices and their applications. But since that time there have been many developments in this field—some of them dramatic, some of them exceedingly important to specialized inter-

ests; yet, of whatever nature, technicians in all fields to be up-to-date must keep themselves informed concerning them.

Service men, engineers, experimenters and beginners will find many ideas, articles, descriptions and accounts of things of interest, in the forthcoming April Electronics Number of RADIO-CRAFT, on the newsstands March 1.

HUGO GERNSBACK, President I. S. MANHEIMER, Secretary
 Published by Continental Publications, Inc. Publication office: 404 N. Wesley Ave., Mount Morris, Illinois. Editorial and Advertising Office: 99 Hudson Street, New York City. Chicago Advertising Office: L. F. McClure, 919 North Michigan Avenue, Chicago, Ill. Western Advertising Office: Loyd B. Chappell, 511 So. Alexandria St., Los Angeles, Calif.

European Agents:

London—Gorrings' American News Agency, 9A Green St., Leicester Square, London, W. C. 2.
 Paris—Messageries Dawson, 4 Rue Faubourg, Poissonniere, Paris, France.
 Australian Agent: McGill's Agency, 179 Elizabeth St., Melbourne.

RADIO-CRAFT is published monthly, on the first of the month preceding that of date; its subscription price is \$2.50 per year. (In Canada and foreign countries, \$3.00 a year to cover additional postage.) Entered at the post office at Mount Morris, Ill., as second-class matter under the act of March 3, 1879.

Text and illustrations of this magazine are copyright and must not be reproduced without permission of the copyright owners. We are also agents for WONDER STORIES and EVERYDAY SCIENCE AND MECHANICS. Subscription to these magazines may be taken in combination with RADIO-CRAFT at reduced Club rates. Write for information.

Copyright 1936. Continental Publications, Inc.

How I Got My Start in RADIO

And Established My Successful

RADIO SERVICE BUSINESS WITHOUT CAPITAL

Read This True Story By

E. LAMAR JOHNSTON, ROME, GEORGIA



E. LAMAR JOHNSTON, Rome, Georgia
 Graduated from the National Radio Institute on February 25, 1929. Today Mr. Johnston owns a profitable Radio Sales and Service business. Maybe you too should get into Radio. Read what Johnston says—then find out what Radio offers. Mail coupon.

"I WAS an untrained worker, with no regular job—sick and tired of skimping along, working for low wages when I could find work—and going farther in debt. One day I saw an advertisement of the National Radio Institute which said that they would train me at home to make more money in Radio.

"Frankly, at first I was doubtful whether I could learn Radio at home, as I knew nothing about electricity or Radio. But I knew that I needed training to get ahead, and Radio struck me as an industry which offered plenty of opportunity for trained men to make good money.

"So I sent for their Free Book, "Rich Rewards in Radio"—and after reading it and

"I started my present business—now one of the largest and most profitable Radio firms in Rome, Georgia—with money I made servicing and selling sets. I had to have training to do this—training which goes far beyond the usual sort—training in ALL branches of Radio.

"That is the kind of training the National Radio Institute gives—the kind a man must have to get ahead in Radio. I honestly feel that any man who wants to make more money—and who is willing to spend a little of his spare time, training—will find success in Radio. Find out what Radio offers you. Send for the National Radio Institute's Free Book today."

(Signed) E. LAMAR JOHNSTON

manufacturers use testers, inspectors, foremen, engineers, servicemen and buyers and pay up to \$6,000 a year. Radio Dealers and Jobbers employ hundreds of servicemen, salesmen, managers, for jobs up to \$75 a week.

Many N. R. I. Men Make \$5, \$10, \$15 a Week Extra in Spare Time While Learning

The day you enroll, N. R. I. starts sending you Extra Money Job Sheets which quickly show you how to do Radio repair jobs. You get plans and ideas that have made good spare time money for hundreds of fellows.

Money Back if not Satisfied

When you enroll, you get an agreement to refund every penny of your tuition if you are not satisfied with N. R. I. Lesson and Instruction Service when you graduate.

64-Page Book of Facts Sent FREE —MAIL COUPON

Mail the coupon for your copy of "Rich Rewards in Radio"—the same book which started E. Lamar Johnston towards success in Radio. It's free to anyone over 16 years of age. It tells you all about Radio's spare time and full time opportunities; about N. R. I. Training; what others who have taken it are doing and earning. Mail the coupon now—in an envelope or paste it on a penny postcard.

J. E. Smith, Pres.
 National Radio Institute,
 Dept. 6CX
 Washington, D. C.



JOHNSTON'S MODERN SERVICE DEPARTMENT in Rome, Georgia. All equipment was bought from Radio servicing profits. Johnston is on the left—his helper on the right.

Many Make \$30, \$50, \$75 a Week in their Own Business or in Radio Jobs Like These

The world-wide use of Radio sets has made many opportunities for you to have a spare time or full time Radio business of your own. Over 20,000,000 Radio sets are now in use in the U.S. More than \$235,000,000 worth of sets and parts were sold in 1934! Millions of sets are going out of date and must be rebuilt or replaced! About \$60,000,000 are spent EACH YEAR for repairs, servicing, new tubes, etc. Radio Sales and Servicing is a TREMENDOUS BUSINESS—with many opportunities for well trained Radio Experts! And Radio offers many job opportunities, too. Broadcasting stations use engineers, operators, station managers and pay up to \$5,000 a year. Radio

learning about their practical Course, and after reading the letters from N. R. I. men who had made good—I enrolled right away. I have never regretted it since.

"The very first lessons I received showed many ways that I could make money. I could start just as soon as I learned them. In a few weeks, I worked three hours and made one five dollar bill clear profit. Every lesson taught me more ways to make money that I could cash in on just as soon as I learned them.

"Working with the Radio parts and equipment which I received as part of the Course showed me exactly how to do actual Radio work. I actually built the circuits and testing apparatus which were described in the Lessons. This made earning money easier and quicker.

"Since that time I have spent all my time in Radio work. I have married, bought my own home—a nice place valued at \$3,500—and have the nicest, most pleasant type of work in the world. My Radio business brings me a good income—and I am my own boss.

ing, new tubes, etc. Radio Sales and Servicing is a TREMENDOUS BUSINESS—with many opportunities for well trained Radio Experts! And Radio offers many job opportunities, too. Broadcasting stations use engineers, operators, station managers and pay up to \$5,000 a year. Radio

GET FREE LESSON on Radio Servicing Tips

Here's proof that N. R. I. training is practical, money-making information, that it is easy to understand—that it is just what you need to master Radio. The sample lesson text, "Radio Receiving Troubles—the Cause and Remedy," covers a long list of Radio receiver troubles in A. C., D. C., battery, universal, auto., T. R. F., superheterodyne, all-wave and other types of sets. Get this lesson free. Mail coupon.

J. E. SMITH, President
 National Radio Institute, Department 6CX
 Washington, D. C.

Dear Mr. Smith: Without obligation, send me the Sample Lesson and your free book about spare time and full time Radio opportunities, and how I can train for them at home in spare time. (Please write plainly.)

Name..... Age.....

Address

City..... State.....

Please Say That You Saw It in RADIO-CRAFT

Announcing Pre-Publication Offer of

Official Radio Service Handibook

by J. T. Bernsley

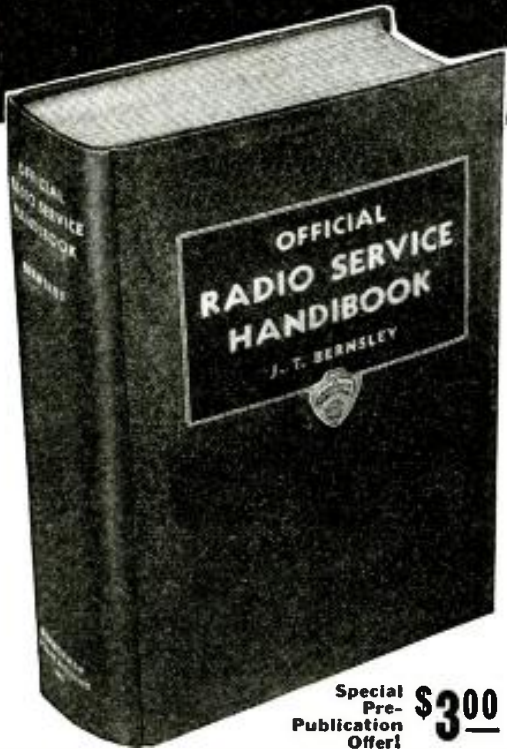

Special Pre-Publication Offer! **\$3.00**

**OVER
1,000
PAGES**

Over 750 Illustrations

6X9 inches

Beautiful Leatheroid Cover

**OVER 250 PAGES
OF OPERATING NOTES**

Whether it is a fading job, lack of sensitivity, noise within the receiver, aligning a chassis, poor A.V.C. action or any other trouble that is usually the "bugaboo" of most Service Men, you will find the symptoms and remedy clearly described in **OFFICIAL RADIO SERVICE HANDBOOK**. The exact procedure for repairing, as well as the characteristic trouble in all, not all models of manufactured sets, will be found in the section on **OPERATING NOTES**—over 250 pages of this data, the most important information to any radio man in the servicing field. The material in this section has been arranged, as well as classified, so there is no difficulty in immediately locating the necessary information.

HERE'S the sensational new book on radio servicing that contains everything Service Men must know. The book, **OFFICIAL RADIO SERVICE HANDBOOK**, is edited by J. T. Bernsley, foremost radio service authority. This 1936 service guide is the *only book of its kind*—its editorial material is so well prepared that the technical information can be understood by even beginners in radio servicing. Every page contains new material, new illustrations—no reprinted literature or rehashed articles.

Over a thousand actively engaged Service Men have helped prepare the service data found in the **OFFICIAL RADIO SERVICE HANDBOOK**. Their contributions, in the form of service notes, short cuts, and trade secrets make this book the outstanding volume on radio servicing ever to be published.

The **OFFICIAL RADIO SERVICE HANDBOOK** covers thoroughly over 500 radio topics. It tells you how to analyze the latest commercial receiver circuits; how to really make money servicing midget sets; and, how aligning supers can be made easy. It stresses the many uses of different types of test equipment; it gives you short cuts in trouble-shooting and repairing; and, contains over 250 pages of operating notes on 1,000 manufactured receivers. So up-to-date is the **OFFICIAL RADIO SERVICE HANDBOOK** that it explains thoroughly what to do when a receiver with the "Magic Eye" goes "cockeyed."

Service Men, previously advised about this great book on servicing, have already ordered their copy. Order your copy NOW if you have not already done so.

SENSATIONAL PRIZE CONTEST!

\$1,800 Worth of Prizes to Be Awarded to Service Men

You should be interested in entering one of the greatest radio contests of all times. There are 147 prizes in valuable servicing equipment and radio accessories, totaling over \$1,800, to be distributed. All the details about entering this contest, including a complete list of the 147 prizes, will be sent upon request—simply mail the coupon below.

Partial Contents of this Great Book

PART 1—CIRCUIT THEORY AND ANALYSIS

R.F. Fundamentals; Superheterodyne Receiver Theory; A.V.C. and Tuning Indicator Circuits; A.F. Fundamentals; Power Supply Theory and Circuits; Speakers, Reproducers and Pick-Ups; Commercial Receiver Circuits of All Types, How to Analyze.

PART 2—MODERN SERVICING AND TEST EQUIPMENT

Fundamentals of Metering and Test Equipment; Standard Servicing Instruments; The Cathode Ray Oscilloscope and Associate Instruments; How to Build Essential Servicing Test Instruments.

PART 3—PRACTICAL SHORT-CUTS IN TROUBLE SHOOTING AND REPAIRING

Localizing Trouble by Inspection Methods; Short-Cuts with Test Instruments; How to Quickly and Properly Perform All Types of Repairs; Unusual Servicing Experiences; Tube Troubles and Characteristics.

PART 4—SPECIALIZED RECEIVER AND INSTALLATION DATA

All-Wave and High Fidelity Receiver Servicing and Installation Data; Auto Radio Receiver and Installation; Specialized Servicing and Installation (Remote Tuning Controls, Home Recording Automatic Record Changers, Apartment House Antennas, etc., etc.); Eliminating Noise Interference.

PART 5—MODERNIZATION AND CONVERSION DATA

Modernizing and Improving Methods for All Types of Receivers; Converting A.C. Receivers for D.C. Operation and Vice Versa.

PART 6—SOCIAL AND ECONOMIC PROBLEMS OF THE SERVICE MAN

Improving Knowledge and Technique; Social Problems—How to Organize; Listing of Servicemen's Organizations; The Future of the Servicing Profession.

PART 7—OPERATING NOTES AND PRACTICAL DATA LISTINGS

Operating Notes on Over 1,000 Receivers; I.F. Peaks of Approximately 3,000 Receivers; Voltage Dividers for 300 Receivers; Speaker Field Listing; Radio Mathematics and Measurements.

**CLIP
COUPON
MAIL
TODAY!**

GERNSBACK PUBLICATIONS, Inc.
99 Hudson Street, New York, N. Y.

RC-336

Gentlemen: Enclosed you will find my remittance of \$3.00, to cover the Pre-Publication Price for a copy of the **OFFICIAL RADIO SERVICE HANDBOOK**. The regular price of this book upon publication will be \$3.00. YOU ARE TO SEND THIS BOOK TO ME POSTAGE PREPAID. It is understood that, should the **OFFICIAL RADIO SERVICE HANDBOOK** ever be offered for sale by a reputable mail order house or dealer for less than this amount, you will refund the difference to me.

SEND ME IMMEDIATELY THE CONTEST BLANK FOR ENTRY IN THE \$1,800 PRIZE CONTEST.

Name

Address

City State

(We accept cash, stamps, money orders or U.S. checks in connection with this offer. If you send cash, be sure to register your letter.)

THIS SPECIAL PRE-PUBLICATION OFFER EXPIRES MARCH 1, 1936

GERNSBACK PUBLICATIONS, INC.
99 Hudson Street New York, N. Y.

Please Say That You Saw It in RADIO-CRAFT



"Takes the Resistance out of Radio"

Editorial Offices: 99 Hudson St., New York, N.Y.

HUGO GERNSBACK, Editor

Vol. VII, No. 9, March, 1936

FAMOUS RADIO BEGINNERS

An Editorial by HUGO GERNSBACK

THE BEGINNER in radio always is interested in what other radio beginners did before his time, and he particularly wants to know what made radio the great art which it is today. In all arts there have been famous beginnings that eventually assumed great proportions. While these beginnings at the time may have seemed unimportant, when looked at from a distance of 20 to 50 years they now assume tremendous importance.

The present art of radio, as most of us know, dates back to the brilliant and *practical* researches of that most famous of all radio beginners, Heinrich Hertz, a famous German research scientist, who did most of his work in electromagnetic radiations about the year 1887 at Karlsruhe, Germany. We have him to thank for the brilliant research work which laid the foundations of modern radio, for his was an effort to experimentally prove the existence of the very waves predicted in 1864 by James Clerk Maxwell of Scotland in a series of masterful *theoretical* researches. It was Hertz, incidentally, who was the first to transmit power by "wireless," (radio) which he did by observing small sparks from a single metal wire loop not connected to his transmitter by any intervening wires. It was also Hertz who demonstrated that the new wavelengths could be refracted similarly to light, an experiment that lay dormant for several decades—or until Marconi later on made use of Hertz's discovery.

Another famous radio beginner was the Frenchman. Doctor Edouard Branly, who invented the coherer—merely a glass tube containing two metal plugs and, between them, metal filings. Branly observed that when the tube was placed in a strong electric field produced by a spark coil (while sparks jumped between the two electrodes of the coil) these filings became highly conductive.

Guglielmo Marconi, another famous radio beginner, had by this time read about Hertz's discovery and Branly's coherer. He put two and two together, added a few ideas of his own, and pretty soon, on his father's estate in Italy, he was able to send and receive "wireless" (radio) impulses over considerable distances by means of improved types of Hertz's spark coil and a spark gap transmitter and Branly's coherer receiver. In due time, Marconi made other notable beginnings. He invented the aerial, and the use of a ground connection, both of which are used in modern radio. Still later he invented the magnetic detector, discarding Branly's coherer. He is responsible also for the tuning coil which was used for many years, and which in one form or another still is used in radio.

Our own Reginald Fessenden, another famous early radio beginner, is responsible for many radio devices that have stood the test of time. It was he who gave us the electrolytic detector which he patented in 1903. This detector was far more sensitive than any that Marconi and other radio beginners had used up to that time. Because of its great sensitivity it was used for many years. Fessenden also invented the high-frequency alternator, which was used (and still is used today) for certain types of long-wave commercial transmission.

Another famous American beginner was Greenleaf W. Pickard. It was he who experimented with all sorts of substances for use as detectors, and it was he who gave us the *silicon* detector, the *galena* detector, the famous *perikon* detector, and many others.

Long before this there was still another famous beginner in radio, none other than Thomas A. Edison. It was he

who really was responsible for the present-day vacuum tube. 'Way back in the 80s, Edison discovered what is now known as the *Edison effect*. He found that if you sealed within a glass bulb two independent filaments which do not touch anywhere, you could make an electrical current jump the space between the two glowing filaments, by *electronic emission*. However, Edison did not do much with this important invention—he had many more important ones to play with—until the English scientist Ambrose Fleming came along and used the idea (with some modifications) as a wireless (radio) detector.

Fleming used a heated *filament* and a cold *plate*. This became known as the *two-element Fleming valve*, because it acted exactly as a valve, wholly in an electrical sense.

Our own Dr. Lee deForest who had heard about this valve began to experiment with it, and he soon found that in many respects it was a very unsatisfactory device. He, in turn, made a new "valve" by adding a third element—the so-called *grid*—between the filament and the plate. From this early beginning the modern radio vacuum tube evolved. Because of its extreme sensitivity the deForest vacuum tube as a detector reigned supreme over the radio world for several decades; in fact, due to this, and its ability to function as an R.F. and A.F. amplifier and oscillator, the entire radio industry has been reared upon the vacuum tube.

Soon deForest made another notable and perhaps the most notable radio beginning, when he discovered *regeneration*. This immediately made the vacuum tube circuit so tremendously sensitive (responsive) that it was possible, and is possible today, with a single tube to bridge distances of 3,000 miles, and more, in radio reception!

Early in 1909 deForest using the vacuum tube as transmitter began sending out radio telephone impulses through space. One of the first emissions was a Caruso phonograph record which was thus broadcast for the first time. Astonished radio amateurs from New York City almost fainted when they first heard clear music in their ear phones, where heretofore there had only been dots and dashes. But broadcasting did not begin in earnest until Westinghouse station KDKA at Pittsburgh through the endeavors of one of its engineers, Dr. Frank Conrad, another famous radio beginner, started broadcasting in the Pittsburgh area. In a few months, hundreds of broadcast stations sprang up over the entire country, and the *radio age* had really begun.

But what was badly needed were better and more sensitive radio circuits, so a number of other "radio beginners" started to improve these circuits or hookups; particularly outstanding among these men were Dr. Hazeltine in this country and Marius Latour of France, both of whom became responsible for *tuned radio frequency* circuits.

But still more important radio circuits were yet to come. Pretty soon the *superheterodyne* was invented; this hookup, one of the most famous in radio, is used today to the exclusion of almost all others. This circuit was invented in France by Levy; but Latour, already mentioned, also did valiant work on this circuit.

Another famous beginner is our own Professor Edwin H. Armstrong, to whom we are indebted for many brilliant circuits; including improved superheterodynes, as well as one circuit which, being extremely efficient on short wavelengths, is coming into great prominence, namely—*super-regeneration*.

THE RADIO MONTH

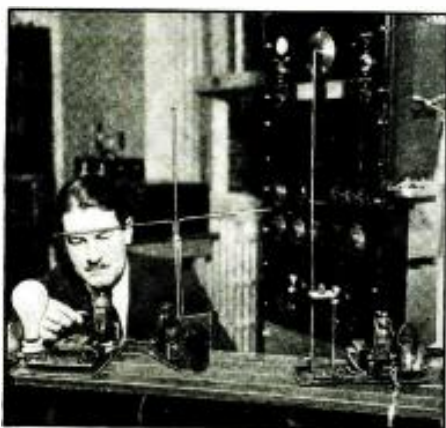

T. S. McCaleb with his ultra-short wave burglar alarm system in his laboratory.

ULTRA-SHORT-WAVE BURGLAR DETECTOR

LAST month, Thomas S. McCaleb, an instructor at Harvard University announced the invention of a new type of burglar alarm operating on radio principles and utilizing an ultra-short wave transmitter and receiver at opposite sides of a room to be protected.

The transmitter sends out signals on a wavelength of 0.7-meter. These signals are reflected back and forth by the walls of the room in an almost infinite number of paths before reaching the receiver.

A body coming into the room acts as a mirror, reflecting the radio waves, thus changing the intensity of the signal picked up by the receiver. This change can be made to operate an alarm.

By a suitable recording apparatus, the movements of the person in the room can be recorded. And since the entire interior of the room is occupied by the numerous reflected waves, this type of detector represents a distinct improvement over the photo-cell type.

The inventor also points out the possibilities for locating planes, etc.

POLICE RADIO SAVES PATIENT

THE police radio service of New York gave dramatic proof of its effectiveness last month, in quickly locating a physician needed for an operation.

Dr. M. F. Wiener of Brooklyn had left for Manhattan in his car when a call came from a patient with an abscess in her throat which threatened to cut off respiration. A city-wide police call was made and 5 minutes later Dr. Wiener was ordered to the curb by a police car.

He rushed to the address of the sufferer escorted by the police car and was in time to perform an emergency operation!

UNCLE SAM TAKES UP S.-W. BROADCASTING NEW TRANSMITTER FOR WNYC

IN A statement made last month G. H. Payne, Federal Communications Commissioner announced that the U.S. Government would make use of 5 short-wave channels to broadcast "ad. free" programs to South American countries.

Commissioner Payne said, in part, that the people of South American republics are becoming "riled" by our "faulty elimination" and "cure-all blackheads" programs. He continued, "... while we may not be unwilling to have the blatant and objectionable stuff pumped into our homes over the radio, we haven't the right to inflict the same stuff on the people of a friendly and unoffending foreign nation."

The F.C.C. appears to have awakened to the fact pointed out by Hugo Gernsback in an editorial in the Feb. 1936 *Radio-Craft*. We quote: "It would seem that all broadcasters must realize that to hold their audiences the first requisite is worthwhile programs, but this truth appears never to have dawned on the majority of broadcasters. They still go out to grab everything in sight when it comes to business, accepting the most blatant and untruthful advertising..."

Construction of one transmitter, at Arlington, will be under way shortly.

5-METER RADIO INVADES CHINA

IN A letter from the Editor of *Popular Radio Magazine*—a magazine published in Shanghai—to *Radio-Craft*, last month, we learn that the use of 5-meter equipment has now taken hold in ancient and far-off China.

It seems that when the 6th annual National Athletic Meet was held, recently, 5-meter transceivers were used to report the results of the various events from all parts of the field to the newspapers and news syndicates.

The Chinese 5-meter transceiver in use on the athletic field during the "meet."



INFORMATION was received last month that the municipal station of New York City is planning to erect a new transmitter costing about \$54,000.

The humor in this news is the fact that less than a year ago, New York was seriously thinking of discontinuing this station because of the cost of operating it. But, then, Uncle Sam's WPA is footing the bill for the new station!

NEW SYSTEM FOR "CONTROLLED" SOUND

A NEW method of "stereoscopic" sound recording that is expected to prove invaluable in the motion picture industry was announced last month by S. W. Coombs, a Columbia University senior. Through the use of several microphones placed at strategic points on the movie studio set, and an ingenious electrical circuit which automatically controls them, the system functions in such a way that only the microphone nearest the performer will pick up any of his remarks. Thus, as he moves about the "set" he will come into various microphone areas and, as he does, different mikes cut in and out.

Meantime, the microphones carry his remarks to the sound track on the film but in addition to this, a "control" track is also being recorded on the film—making a record of each microphone as it is brought into use.

Now, when the film is being run in the theatre where loudspeakers have been placed in certain positions behind the screen, the control track on the film permits only the reproducer nearest the performer's position on the screen to reproduce his remarks.

The single stereoscopic control knob on S. W. Coombs' portable P.A. amplifier.



IN REVIEW

Radio is now such a vast and diversified art it becomes necessary to make a general survey of important monthly developments. RADIO-CRAFT analyzes these developments and presents a review of those items which interest all.

NBC HEAD RESIGNS IN RCA SHAKE-UP

IN A wide-reaching reorganization of the huge Radio Corporation of America for the purposes of recapitalization in order to permit the use of its cash surplus for stock dividends, the well-known president of the National Broadcasting Co.—M. H. Aylesworth—offered his resignation last month. NBC is controlled by RCA and was thus involved in the reorganization.

Mr. Aylesworth asked to be relieved of his responsibilities because of his duties on the board of Radio-Keith-Orpheum.

He is succeeded by Lenox R. Lohr—who successfully managed the Century of Progress Exposition in Chicago.

RADIO SUPPLIES EMERGENCY TELEPHONE COMMUNICATION

IN ONE of the hurricanes which struck the Florida Keys recently, telephone communication was completely cut off due to telephone poles being washed out.

News was received last month that the telephone companies resorted to radio equipment to temporarily restore these communication lines, until the wires could be re-erected and the power on Big Pine Key could be restored.

Two sets of aircraft transmitters and receivers were taken to Big Pine Key by boat and set up in temporary shacks. Within 2 days, full telephone service was restored thanks to this radio equipment. Transmissions from west to east used a frequency of 5 mc. while transmissions from east to west used 4 mc.

Emergency set-up of aircraft transmitter (left) and receiver (right).

(Photos, Bell Labs.)

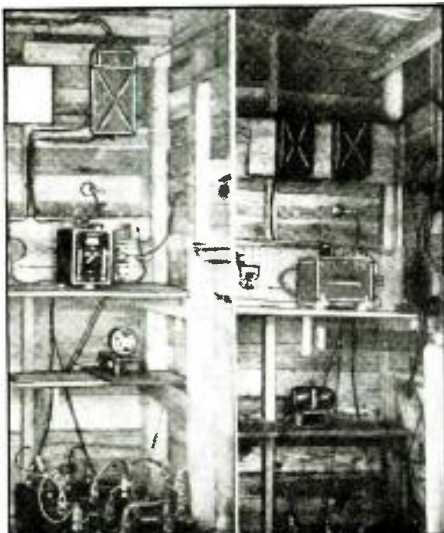

FREQUENCY MODULATION DEMONSTRATED

THE long-expected public demonstration of Professor Armstrong's ultra-high frequency system of transmission by frequency modulation became a fact, last month, at a meeting of the Radio Club of America, in New York.

Communication was set up between Pupin Laboratory at Columbia University where the meeting of the Club took place, and amateur station W2AG, in Yonkers, about 12 miles away.

Station W2AG operated on 2½ meters as a frequency-modulated station having a power of about 100 watts.

Professor Armstrong, in concluding the demonstration and lecture stated, "While I do not like to make predictions, I feel that this demonstration will give an idea of the broadcasting of a few years hence . . . It will not be many years before the only noise heard from lightning will be the audible sound of thunder. The static crashes in the radio receiver will be entirely eliminated."

Several sound records were run off from records made during a thunder storm and while WEA and WMCA in New York were entirely "snowed under" the frequency modulated transmissions from the Empire State Building transmitter were almost entirely free from static and back-ground noises!

INTERNATIONAL BRIDGE BY RADIO!

WHEN Mr. and Mrs. Ely Culbertson played their international contract bridge match, last month, radio played an essential role in keeping constant communication between New York and Buenos Aires.

Two official "dummies" made the plays called for by the opponents who were over 6,000 miles away, thus demonstrating another of the myriad of uses to which radio is being applied!

The international bridge match in progress. Note the broadcast and short-wave "mikes."



The Immigration Service station in Detroit.

RADIO COMBATS ALIEN INFLUX

A 2-WAY radio system between a temporary headquarters set up in Detroit, and boats and scout cars was put into operation last month by the U.S. Immigration Service in an attempt to halt the increased numbers of aliens making illegal entry into the U.S. due to the improved business conditions here.

Detroit has been the goal of most of the illegal entries because of the booming of the auto industry.

The radio system at Detroit has already aided materially in stemming the illegal tide in the short time it has been in operation. Similar 2-way radio systems will be put into operation at other border stations, including the Mexican border and along the Canadian line.

NETWORKS CEASE USING POPULAR SONGS!

MANY of the best-known and most popular songs of the past few years were silenced over the NBC and CBS networks in the beginning of January as a result of the withdrawal by Warner Brothers Pictures Inc., from their agreement with the American Society of Composers, Authors and Music Publishers.

ASCAP is the intermediary between the music publishers and the broadcasters, and the music publishers are controlled for the most part by Warner Brothers. It is said that about 40 per cent of the music played over the radio networks is owned by this company.

This action by ASCAP will no doubt provoke a court battle as many of the theme songs used by radio performers are included in the banned music!

(Continued on page 556)



THE "RADIO" BEGINNER

The radio beginner and beginnings in radio, are discussed in this article. The author draws comparisons which tend to show that the beginner is a perennial asset.

R. D. WASHBURNE

INSTALLED on the wall of the RCA license laboratory in New York is the original of the photo mural mosaic that appears at the heading of this page. It aptly illustrates one phase of activities today available to a "beginner in radio." For, this composite view portrays a story of broadcast engineering, starting with inception in the laboratory and on the drawing board, then to the production and the finished instrument, next the contribution of the broadcasting artists, and finally the listening public. But here let us add that we must consider as being included in this summary the "radio" services listed in Table I.

Table I

Mobile radio (airplane, automobile, boat, train, etc.)
Public address, and sound reinforcement
Electronics
Sound recording
Radio therapy
Ultra-short waves
Electronic music
Radio dynamics
High fidelity, and controlled sound
Multiplex telegraphy and telephony
Television

(Photo—from "Good News," courtesy: RCA Radiotrons)



FIRST "BEGINNERS"

Back in 1895 Senatore Marconi was a "beginner" in radio, as he experimented with the radio transmitter and receiver that Hertz perfected as nearly as he could in the light of his knowledge in 1887. In 1905 Dr. deForest was a "beginner" in electronics and its application to radio transmission and reception as he experimented with Thomas A. Edison's vacuum tube. Today, technicians in all the branches of "radio" in Table I are but beginners, as they experiment with the perfected developments of yesterday. In short, the beginner we have with us always, and always his endeavors are part of an ever-widening circle of activities.

This circle which we here designate by the single word "radio," in 1887 was of extremely small dimensions when it included only the work of Hertz and his predecessors. Today, on the other hand, the "radio" beginner in the aggregate is an extremely versatile and powerful agency in technical progress.

OTHER "BEGINNERS"

It hasn't always been plain sailing for the man with an idea. About 60 years ago Alexander Graham Bell was having his own troubles trying to interest capital in his telephone invention, as the following quotation from a Boston paper of the time, concerning one of his colleagues, tells us:

"A man about 46 years of age, giving the name of Joshua Copper-smith, has been arrested in New York for attempting to extort funds from ignorant and superstitious people by exhibiting a device which he says will convey the human voice any distance over metallic wires so that it will be heard by the listener at the other end. He calls the instrument a 'telephone' which is obviously intended to imitate the word 'telegraph' and win the confidence of those who know of the success of the latter instrument without understanding the principles on which it is based.

"Well-informed people know that

it is impossible to transmit the human voice over wires as may be done with dots and dashes and signals of the Morse Code, and that, *were it possible to do so, the thing would be of no practical value!* The authorities who apprehended this criminal are to be congratulated and it is hoped that his punishment will be prompt and fitting, and that it may serve as an example to other conscienceless schemers who enrich themselves at the expense of their fellow creatures."

This amazing description (although it has been branded false), calls to mind an experience of *Radio-Craft's* publisher and editor. Looking up one day, about 1904, from the desk in his retail "radio" store, the first of its kind in the country, Mr. Gernsback found himself confronted by a husky representative of New York's "finest," who was all prepared to escort the proprietor of Electro Importing Co. to the lock-up. The officer was not quite certain as to the charge he was to bring, but anyway it had something to do with selling a "wireless machine" that was supposed to "send messages" over distances of a few hundred feet. After a lengthy sales talk, and demonstration of a sparkcoil and coherer-decoherer set-up, the minion left the scene of battle, but not without making it plain he wasn't any too sure the whole thing wasn't an out-and-out trick of some sort that he couldn't quite fathom!

As we shall see, time erases old prejudices.

OUT-MODED IDEAS

For a long time it was believed that radio was doing more harm than good, to the newspaper industry. But when the Rogers-Post crash produced enormous circulation gains for every paper in the country, a quick check-up by *Newsdom* (the newspaper industry's own newspaper) revealed that radio news flashes which preceded the "extras" were the force which drove people to the newsstands in unprecedented numbers on that day.

Old-timers in the radio game do not have to look (*Continued on page 550*)

A BEGINNER'S SET USING THE NEW "F.C.T." DETECTION SYSTEM

Here is a brand new method of detection which provides the sensitivity of grid-detection; the power capacity of plate-detection and the quality of the diode.

"F.C.T." (*à faible constante de temps*—which means, a very small time constant) detection usage bids fair to become almost standard practice in future radio receiver design, inasmuch as this system is described—by Jean Dieuzy, its French inventor—as affording the high-fidelity characteristic of diode detection with the sensitivity that is usually associated with square-law or grid-leak detection and the power-handling ability of plate detection. For this reason the F.C.T. circuit has been applied to a complete receiver, as here illustrated.

PERMISSIBLE VARIATIONS

Although somewhat special parts, such as metal tubes and iron-core R.F. transformers, are specified in the List of Parts, they are included in this set for maximum efficiency as a convenience to the beginner in radio who may wish to use modern commercial components. Inasmuch as the circuit is not extremely critical the experimenter is at liberty to substitute such approximately equivalent items as he may wish. A large chassis was used merely to show more clearly the placement of parts. Although trimmers CA1 and CA2 will align the circuit at the low-wavelength end of the dial, the V1 plate-to-cathode capacity introduced (because of the system of "plate circuit tuning" required in order that both condenser rotors may be made common) in shunt to the L2 resonant circuit may

make it difficult to maintain resonance right to the end of the tuning range. At this high-wavelength end of the range better alignment may be secured by reducing the capacity of coupling condenser C4.

POWER SUPPLY

The use of 6.3 V. tubes was determined upon for a number of reasons. In the first place, this makes it convenient to operate the entire receiver on D.C. or A.C. power lines, or from a 6V. dry-cell or storage battery, for filament supply. In the instance of power-line operation either a built-in power pack may be incorporated on the chassis (which is adequately large for this purpose), or an eliminator may be used, in order to secure the requisite high voltages. In battery operation either a vibrator-type "B" unit or regular batteries may be used to supply the screen-grid and plate voltages. Due to the use of cathode-type tubes the filament voltage is not at all critical in value.

The circuit has been designed in such way that the tuning condensers may be mounted directly onto the metal chassis, and this chassis may be grounded with respect to the negative "B" connection. Consequently, the chassis may be "alive" when potentials are derived from a D.C. power line; in which instance this fact must be kept in mind.

In the schematic diagram it will be observed that the plate of tube V2 is connected to (Continued on page 552)

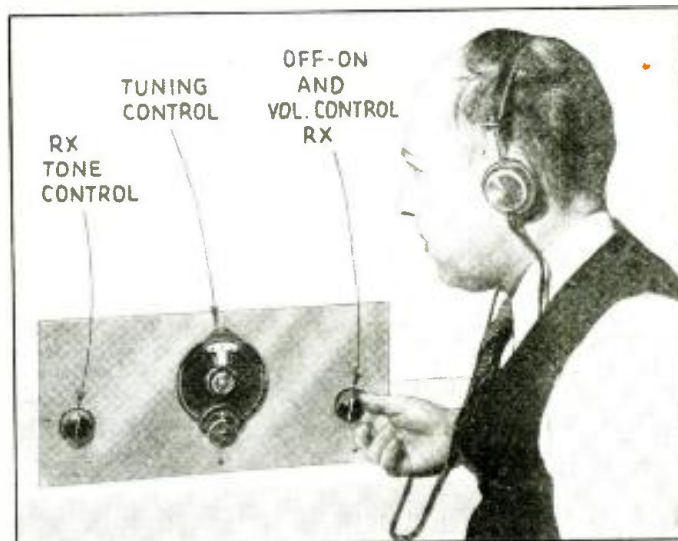

THE THEORY OF F.C.T.

Jean Dieuzy

IN THE circuit at Fig. 1A, a screen-grid tube is connected in the following fashion: the screen-grid, being used as an anode (plate) is connected to the "B" supply (about 60 V.) while the plate, connected to a potentiometer, can be supplied with variable negative and positive potentials with respect to the negative extremity of the filament. Milliammeters, inserted in the circuits of the screen-grid and plate, indicate the respective currents passing through these circuits, and a voltmeter (V) indicates the value of the potential applied to the plate.

Under these conditions, if one watches the voltmeter, one will discover the following:

(1) When the potential on the plate is negative, no current is circulating in the plate circuit; as soon as it becomes positive a current flows.

(2) When the plate potential is negative the current in the screen-grid circuit (which we may call the second-plate or anode current) shows no change, no matter what the value of the potential may be; however, when the plate becomes positive, there is produced a lowering of the screen-grid current to an extent equal to the value of the current which is flowing in the plate circuit, in such a way that I_p (plate current) + I_{sg} is a constant.

The phe- (Continued on page 552)

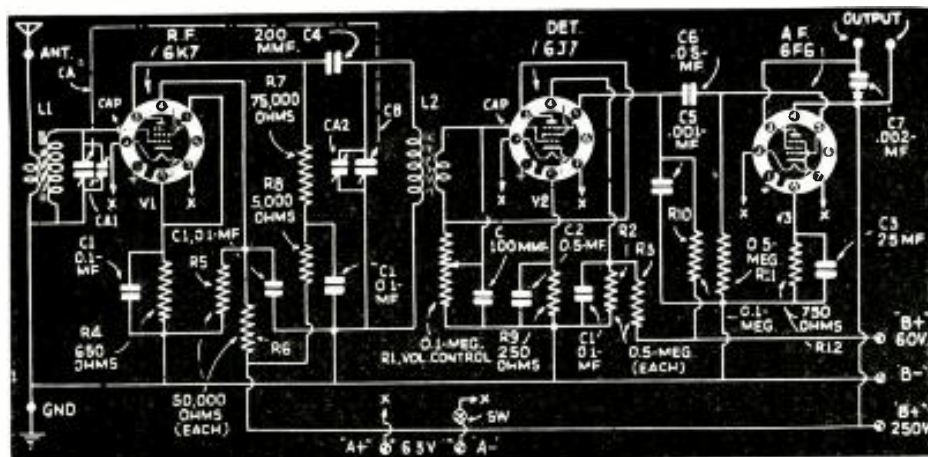

Left. The circuit of the 3-tube experimental set using the new F. C. T. system of detection—for the beginner.

Fig. 1, below. The fundamental circuit and characteristic of the F. C. T. detector.

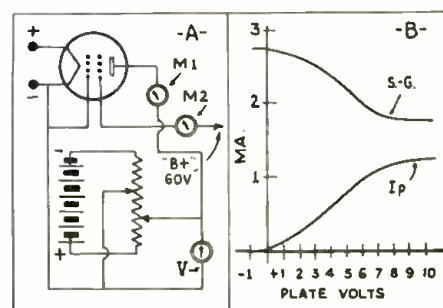

RADIO PICTORIAL

A complete television and sound receiver; and a radio construction kit for the beginner.

A LARGE GERMAN TELEVISION SET FOR THE HOME. It employs the largest cathode-ray tube ever used for television. By its use an image of home movie size is reproduced. Below is the 5,000V. power supply.



The actual size of image on this machine is 10x12 ins.! The machine operates at 180 lines and reproduces 25 frames per second. The impression is equal to a 300-line picture.

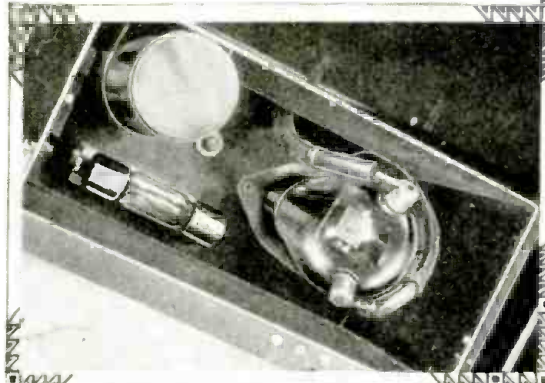

The normal or receiver power supply is at right. This supply is used for all but the cathode-ray tube. The power supply for the latter is required by the Underwriters to be specially shielded, and a contact disconnects the entire receiver from the power lines the moment the top of the shield is lifted. The ultra-short-wave receiver at right is used for pickup of sound impulses. The I.F. stage in this set is not very selective. *Telefunken*

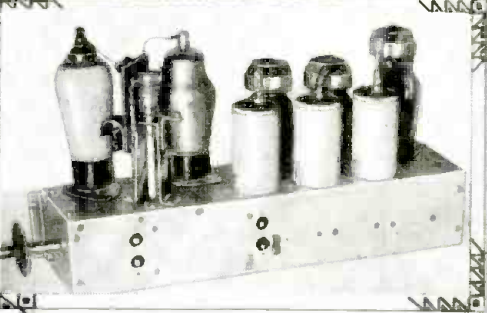
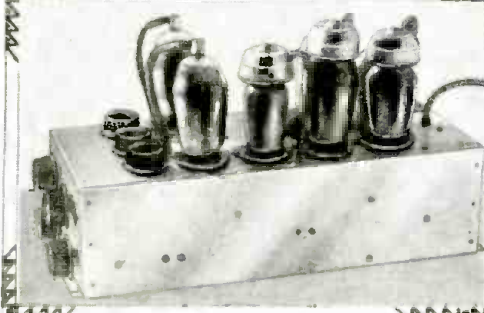
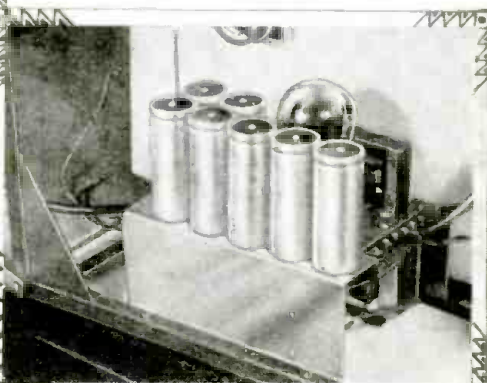

The sweep circuit is on the chassis above. The tuning controls at the left are adjusted and sealed at the factory. The short-wave receiver at the right has an I.F. amplifier bandwidth of 7,000 cycles, and is used only for reproduction of the sound signal.

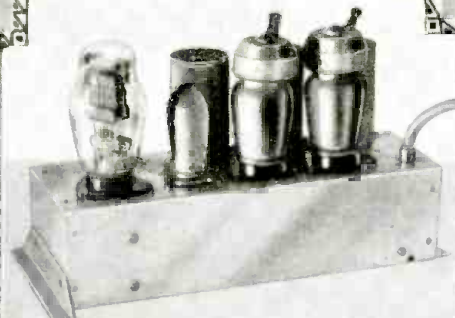

The right side of this unit is used as an image I.F. amplifier and has a band width of 1,000,000 cycles. The tube near the ultra-short-wave coils is the mixer, while the tube at the extreme left is a broadly-tuned R.F. stage which is used for pick-up of both image and sound impulses!



RADIO CONSTRUCTION SET FOR YOUNG PEOPLE. Set-ups possible with the construction outfit are depicted here. The various phases of radio are taught in the most "painless" way by means of such apparatus, and the lessons thus learned are not soon forgotten. A few special experiments require the use of a 100 V. battery. Even headphone and tools are provided.

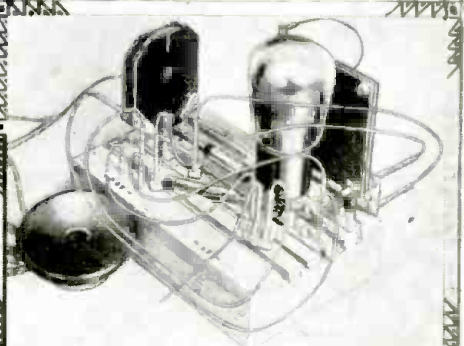

Above we see two youthful German experimenters busy at work on a piece of radio equipment they have made from a set of construction parts put out by the German firm of Siemens & Halske. A view of this equipment is seen at the right. There are over 170 separate parts, all made very carefully and of the best materials. There are 150 different combinations that can be made from this unit. The only batteries required are a few flashlight cells. *RPS*

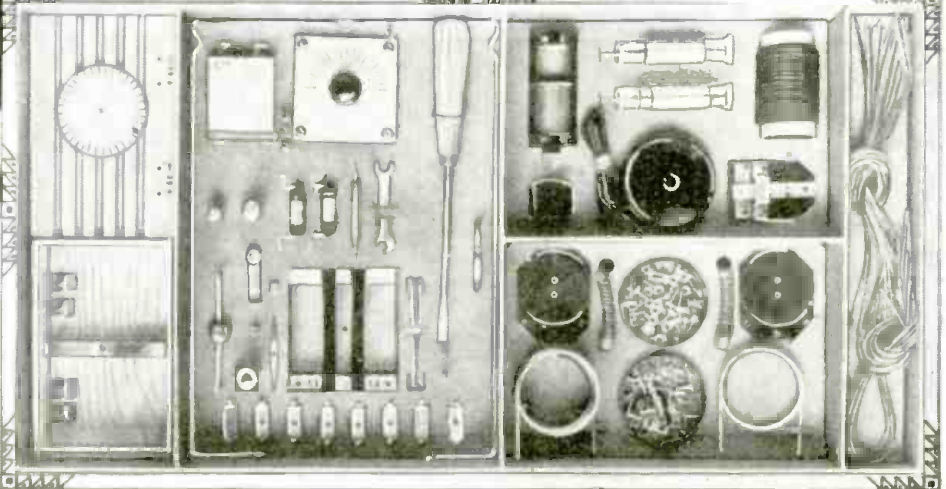



A 16-TUBE RECEIVER IN A GLASS CASE. This display set has all parts in the same places they occupy in the conventional outfit. The sides are of 1/2-in. thick plate glass, held together by a welded steel frame. All metal parts are finished in polished chromium. Complete set weighs 200 lbs. (Photo courtesy Wholesale Radio Service)

ACOUSTICALLY-TREATED MONITOR ROOM. Note features A and B; the ceiling is of saw-tooth design while the walls are partly covered with plates of wood which have small slits in them. The window at right faces the stage. The baffle has two units mounted in it—a regular speaker and a tweeter which has a stretched aluminum diaphragm.

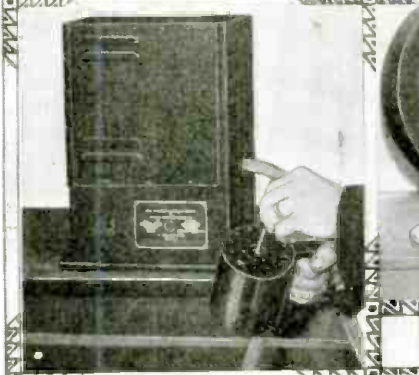
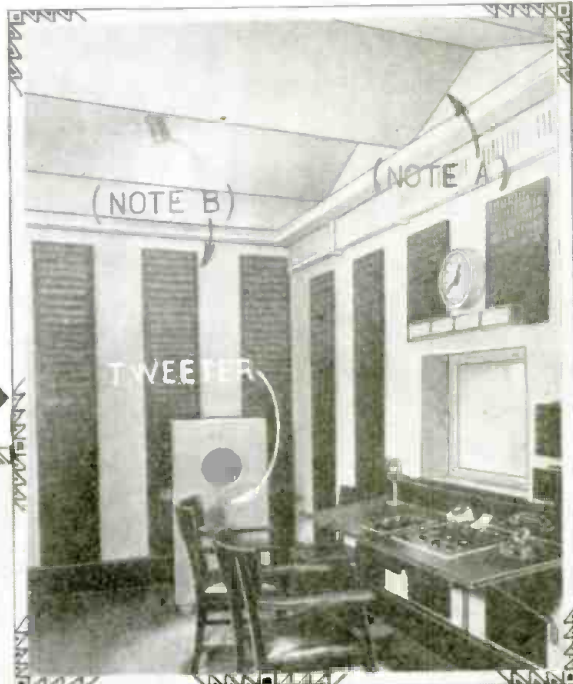

FURNACE TREATS SMALL TOOLS Radio-frequency currents are supplied by this machine to heat tools to the required degree. It is very useful where gas furnaces are not available or where it is too costly to start up a large furnace for a few tools. The latter are simply stuck inside the coil connected to the box. (Westinghouse photo)

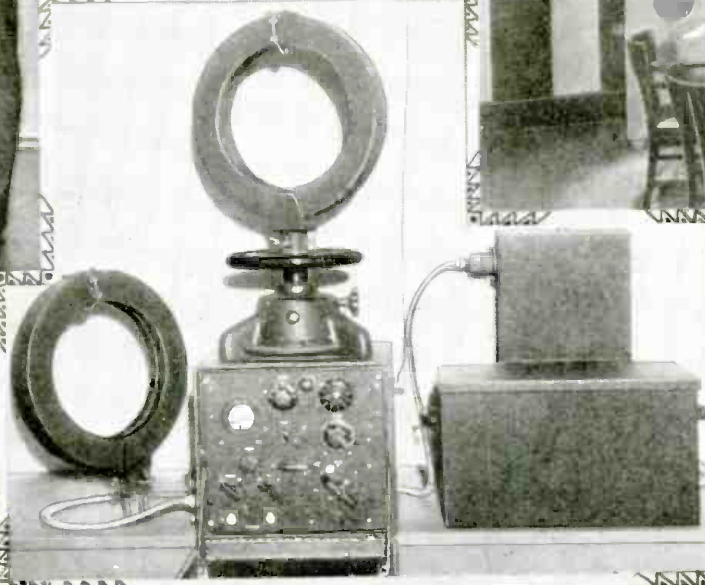

PORTABLE DIRECTION FINDER Interchangeable loops are used with this equipment, which has a frequency range of 200-750 kc. and 2,000-18,000 kc. It is used in Coast Guard stations for emergencies in conjunction with rescue work, and for communication between small ships and the shore. The apparatus is entirely weather and corrosion proof. At top-right is a charger unit; bottom-right, battery and power box; center, the receiver.



NEWEST TYPE KERR CELL. This was developed for television work by W. H. Peck. It is used to modulate the light beam; the bulb is almost entirely liquid-filled.

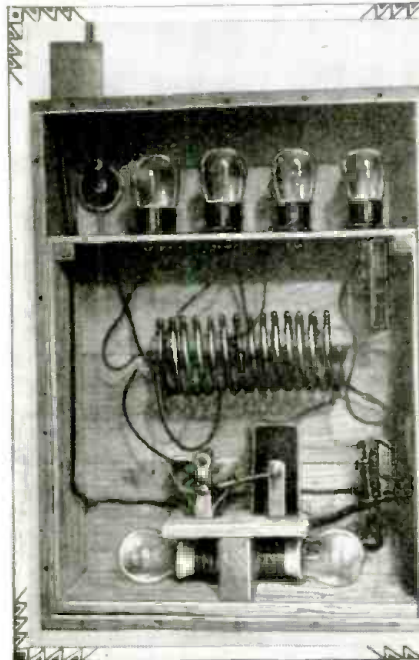

AUTOMATIC RADIO STATION. The Russian meteorological service has a number of such sets installed on various mountain peaks. The equipment has been very satisfactory in all cases. The signals from all the stations are received at the Central Meteorological Institute. The equipment was perfected by Prof. Molchanov, in the Aviation Institute.

INVENTION FOR RECORDING BROADCASTS. A young Russian inventor, Ivan Nechipurenko, has developed a machine to receive, record, and reproduce radio broadcasts. The machine makes it possible to reproduce the program after it has been broadcast. Recordings are made on film.



(Sorfoto)

THE LATEST IN TUBE DEVELOPMENTS

The most recent types of metal and glass tubes, including a new type of metal tube with improved vacuum seal, are here described.

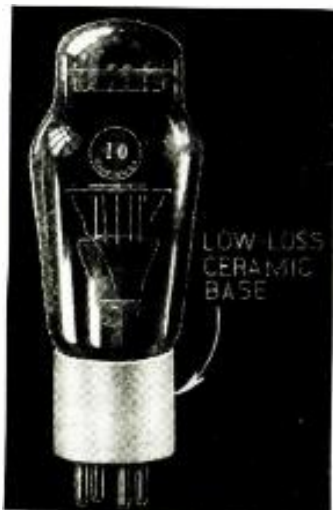

Left. A high-frequency type 10 having a ceramic base to reduce losses. Below. A 6H6 metal tube having an improved vacuum seal.

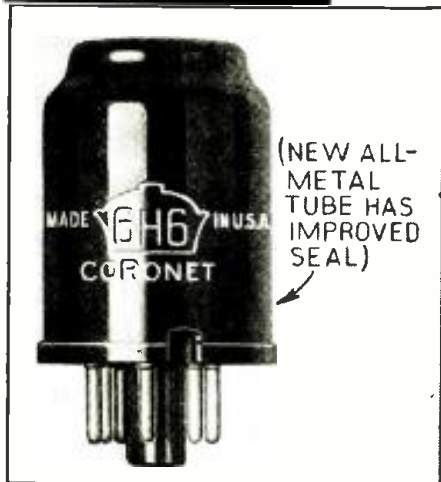

Type 10, special high-frequency tube. The type 10 tube is used extensively for high-frequency work, but the bakelite base is not a very satisfactory insulator. This new "special high-frequency" 10, however, is provided with a ceramic base which greatly increases the efficiency for such work. It is otherwise the same in characteristics (even, unfortunately, to the type number) as the "ordinary" 10. (Hygrade-Sylvania Corp.)

A new range of tubes by a well-known manufacturer (name upon request) utilizing what is said to be a new and exclusive principle in receiving

tube structure, a "coronet" seal, has been announced as an all-metal tube series. This special "coronet" seal is said to result in material reduction of the input and output capacities and makes possible uniformity in inter-element capacities. This seal also precludes the possibility of shorts between wire and ground. A special process has been developed to permit proper bombardment of the internal elements of the tube at the temperature necessary to dispense with residual gas troubles. The manufacturer of coronet tubes claims (Continued on page 554)

Right. Three metal tubes—the 6X5, a high-vacuum rectifier; the 25A6, a power pentode with a 25 V. filament; and the 25Z6 a metal equivalent of the 25Z5.

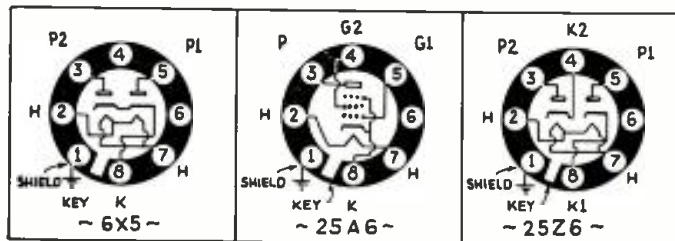

Above, the appearance of an A.C. powered signal generator, especially designed to supply the needs of the Service Man.

Below. The circuit of the instrument shown above. Note the complex attenuator.

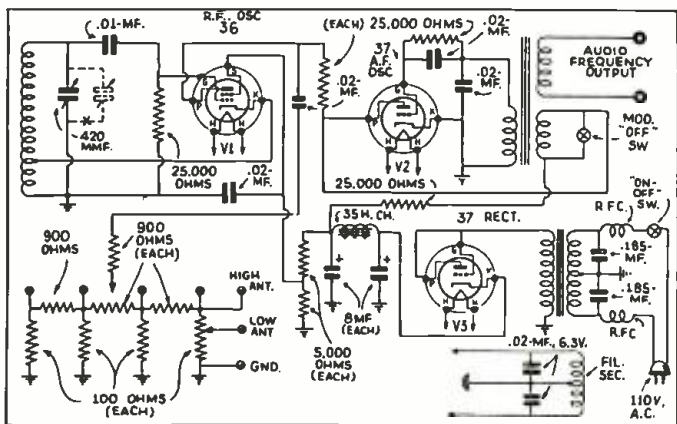

INSTRUMENT NEEDS OF THE BEGINNER IN SERVICING

No matter how clever the technician, the correct selection of service instruments will facilitate the work at hand.

SAMUEL C. MILBOURNE

THERE IS nothing which will help the novice in radio servicing more than a reliable test instrument. He may have all of the theoretical knowledge that a resident technical school may afford, but without the right tools to carry on his work, he is like a carpenter without a hammer!

First of all, let us take up a brief study of the analyzer. This is the instrument by which a radio man actually analyzes the condition of the customer's set. This instrument acts as a stethoscope in diagnosing the set trouble. Without it, a radio Service Man is but groping in the dark, for it is an absolute ne-

cessity if he expects to render real radio service. With it he can test every radio circuit and by experience or recourse to a standard book of diagrams and set characteristics determine just what "ails" the customer's set. The modern analyzer will measure A.C. and D.C. voltage, direct current, ohms and megohms, capacity, etc. It will act as an output meter in set alignment and may even be used to test tubes by the "grid shift" method.

Secondly, we have the problem of some way to test tubes other than by the comparison, or "grid shift" method. There has been a great deal of loose talk in test instrument circles regarding so called "mutual conductance" tube testers. The mutual conductance of a tube is determined by how much the plate current changes with a specific change in grid voltage. However, this change, to actually show mutual conductance, must be taken with the proper grid and plate potentials. Naturally, these vary for (Continued on page 554)

MAKING A 5-METER MIDGET PORTABLE RADIO STATION

These tiny units are of special interest to the "ham" beginner who wants an inexpensive 5-meter station that will really work!

H. G. McENTEE



HERE IS a pair of companion units, one a receiver and one a transmitter, and both small enough to fit easily into the palm of your hand! They are of interest to both the beginner and the experienced, since they are necessarily of the utmost simplicity, to conserve space, yet are perfectly workable and may be used under a wide variety of conditions.

No claims are made for long-distance operation, since they are intended for short-range work. They have been worked together, however, over distances of several hundred feet with no antenna whatsoever. Also, operation between different rooms of a house has been accomplished with great success. The receiver has been used on the 5-meter ham band very successfully, by simply coiling the antenna lead-in in a single loop and laying it on the case, directly over the end of the coils. It must be admitted, though, that a vernier dial would be of some help, and also that an extension shaft to reduce hand capacity would go a long way towards making a "communications receiver" out of this midget. Of course, when used to work with a powerful transmitter or a really sensitive superhet. receiver, the range is greatly increased.

The construction of both units is very similar, the cases and placement of parts being practically identical. The edges of the cases are of 3/16-in. tempered pressed wood, while the sides are of 1/8-in. material. The two sides

are removable, as is one section of the frame (the part referred to, in the drawing, as the bottom). This last piece is made removable in order that the tube may be inserted or removed. It is a good plan to make both cases complete first, then install all similar equipment in each. The two joints in each case are held by a single small screw, and a liberal coating of celluloid cement; cement alone is sufficient for the two cleats to which the bottom is screwed. The sides are held on by screws also, so that they may be readily removed for adjustments.

The tuning condensers are of about 15 mmf. capacity, and are made by removing one rotor and one stator plate from a 25 mmf. unit, this being the smallest size obtainable. Also a bushing 3/8-in. long and 1/4-in. in dia. is soldered to the stub shaft to hold

the tuning knob, to allow adjustments.

The tuning inductances are made of No. 14 hard drawn, tinned copper wire, and all are as nearly alike as possible. The grid and plate ends fasten directly to the socket terminal posts, while the centers are more or less self-supporting, being held only by the wiring. The condensers which connect together the inner ends of the plate and grid coils are of the smallest midget type and are fastened directly to the coil ends.

The R.F. chokes for both units consist of about 40 T. of No. 30 enameled wire, close-wound on 1/4-in. bakelite rods.

The microphone transformer of the transmitter is about the smallest commercially available. It has a core of special alloy. No provision for mounting is made by (Continued on page 555)

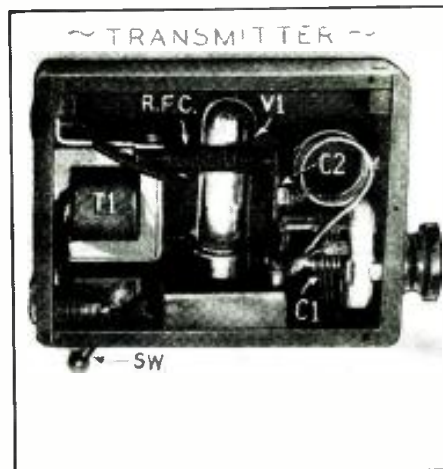

Fig. 8, above. The transmitter "insides." Fig. 1, below. The transmitter circuit.

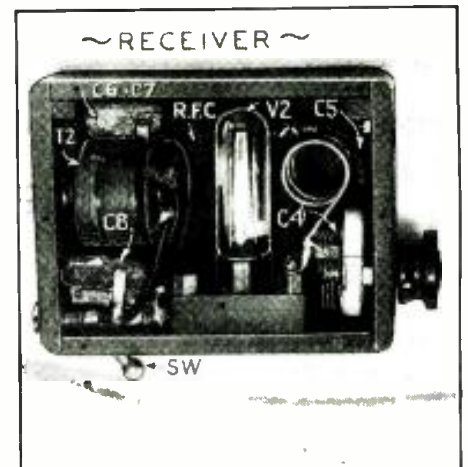
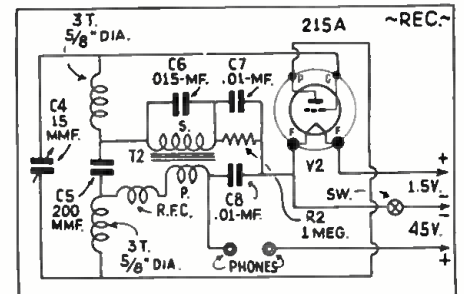
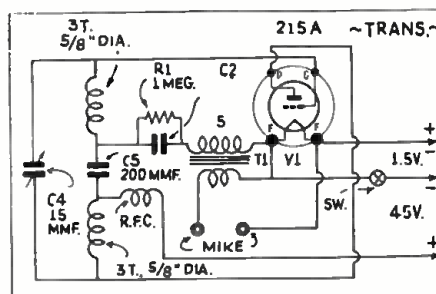
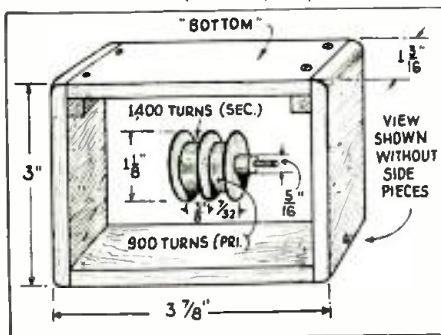

Fig. C, above. The receiver interior. Fig. 2, below. The receiver circuit.





MAKING A GOOD CRYSTAL SET FOR 65c

A set for the beginner in radio which will not deplete the pocket-book. It is extremely easy to make and operate.

FRANK F. JANUSS

ALTHOUGH this little set is made entirely from manufactured parts, the cost is only 65c. The writer has built up quite a trade in parts for crystal sets, among the youngsters of his neighborhood. The only item that could not be obtained ready-made was the tuner, and many of the customers could not make a workable one. This problem was solved when it was found that the ICA No. 93 tuner was just what was needed. This unit is intended for use as an antenna tuner, or wave trap and similar requirements, but is ideal for use in a cheap crystal set.

I have been building up the crystal sets in large numbers and, for the type

of set they represent, they are very effective. The construction is of the very simplest, only 3 wires or connections being necessary. Thus it can be made by the veriest beginner, with little chance of a mistake. For those who wish to buy it ready-made it can be

built up in a short time.

A user in Phoenix writes that he has received KNX, KGO, and KSL. Also that he can get KNX as soon as KOY (1,390 kc.), Phoenix, goes off the air and with KTAR (620 kc.), Phoenix, (Continued on page 561)

The very simple connections between the parts of the set are indicated here. Tuning is accomplished by moving the slider on the coil.

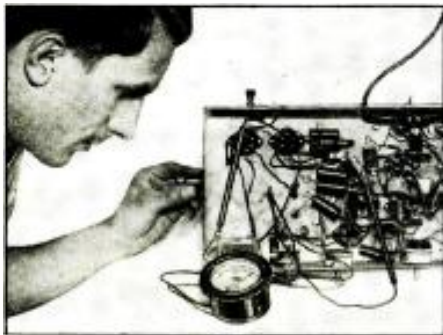
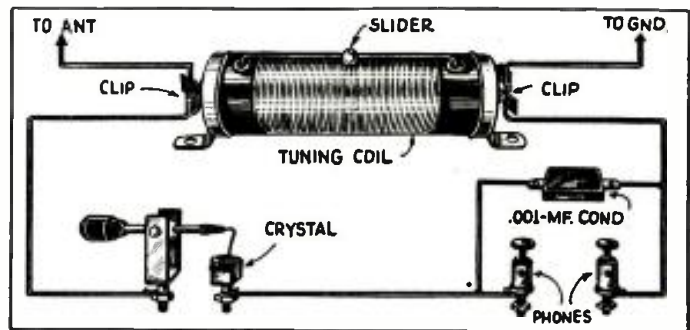

The meter is connected in the cathode circuit of the 1st I. F. tube for all tests.

1-METER SUPERHET. SERVICING PROCEDURE

The author tells how a simple 0-10 ma. meter can make many necessary tests, noiselessly, to service these sets.

F. W. D. PEARSON

IHAVE built radio sets for years and, I suppose like many others, after completing a set and not having oscillators, output meters, analyzers, etc., I was at a loss to know if the set was working efficiently.

With a 0-10 ma. milliammeter all the tests below can be made which will allow the experimenter to adjust the various circuits and parts accurately and get maximum results.

As the meter will only react to a "tuned-in" signal, any change in the component parts of the set will cause a deflection in the meter, which indicates either increase or decrease of signal strength.

With this visual indicator in front of us, it is then easy to adjust each part for maximum results. In describing how to read the meter for the various tests as listed below, it is to be remembered that when the set is turned on with no signal tuned in, the meter will

read full-scale (or maximum); also, that the widest deflection towards zero indicates the greatest signal strength.

Many tests can be performed, as Table I indicates.

Table I

- (1) Tuning meter.
- (2) Align I.F. transformers.
- (3) Align ganged condenser.
- (4) Align split-rotor-plate condenser.
- (5) Indicate efficiency of different antennas and grounds.
- (6) Indicate "R" signal, or strength of station being received.
- (7) Indicate signal swing or extent of fading.
- (8) Indicate automatic volume control action.
- (9) Indicate most efficient coil for the different circuits.
- (10) Indicate most efficient bias and voltages to apply to various circuits.
- (11) Indicate most efficient values to use in fixed condensers and resistors.

(12) Indicate efficiency of tubes by comparison.

In detail, these various tests are made as indicated below:

- (1) As a tuning meter, by rotating the tuning dial of set the meter will deflect toward zero when signal is tuned in, and again return to maximum when (Continued on page 556)

The position of the meter in the I.F. amplifier for tests described.

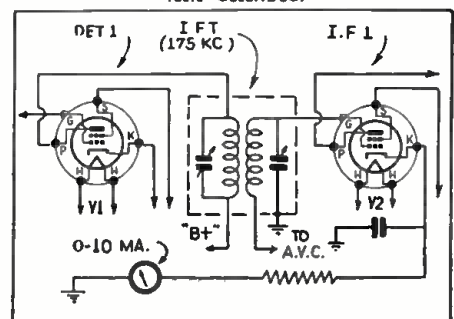

CORNERSTONES OF RADIO —OHM'S LAW

There are 3 fundamental concepts in radio—Ohm's Law, the Wheatstone Bridge, and Phase! Learn these thoroughly for proper understanding of the entire theory of radio.

PART I

E. W. SLOPE

AMONG THE many things which occur in connection with radio experimentation, hardly anything gives the beginner so horrible a feeling as to be obliged to figure out "what is the voltage drop if a resistor of so and so many ohms is applied in a circuit?". We have all learned in school, of course, that there is an excellent formula which solves the problem without great difficulties (as the teacher tried to make us believe), and that this formula is called "Ohm's Law."

When the teacher explained the application of the letters E, I, R, (which are the internationally accepted symbols for voltage, current and resistance, respectively), to figure problems, such as the one mentioned above, it seemed to us like child's play. However, (and why should we not confess it honestly) a few hours after class our opinion of the simplicity of this formula changed considerably, and today many of us have the belief that this Law is a magic trick invented by the devil, or at least created exclusively for the private world of professors; but not a tool to be used by amateurs without having the patience of an angel and the wisdom of an Einstein.

As we shall see later, this opinion of Ohm's Law is prejudiced, because every one of us can understand it. There is nothing mysterious about it which cannot be conceived by an average person. It is, of course, a trick, but one which is by no means reserved

especially for university graduates.

A FRIENDLY INTRODUCTION TO MISS ELECTRICITY

To prove that the judgment of the author is correct let us look over the facts actually involved in the relations which exist between the three fundamental units of electrical power: Volt, Ampere and Ohm. Why do we become frightened by these units of electricity, when the much more complicated units of weight (the "ounce"); length (the "inch"); and especially the unit of money (the "dollar") do not frighten us? However, this uneasy feeling in connection with the units of electricity will disappear and even Miss Electricity herself shall not frighten us if we once become really acquainted with her.

WHO IS MISS ELECTRICITY?

May I introduce to you Miss Electricity? She is of Greek parentage, and had quite a lot of influence upon Greek ladies who got from their boyfriends or husbands beautiful yellow stones which were also admired by our grandmothers and mothers and are even well known and liked by ladies of today under the name "amber." This stone as we know is the petrified resin of coniferous trees, which grew some millions of years ago in the vicinity of the Baltic Sea. To what extent this amber jewelry is able to influence the mind of a girl of today cannot be discussed

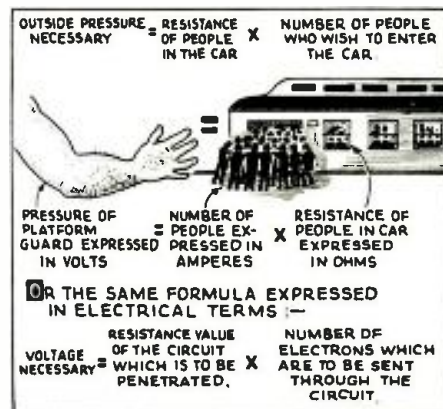
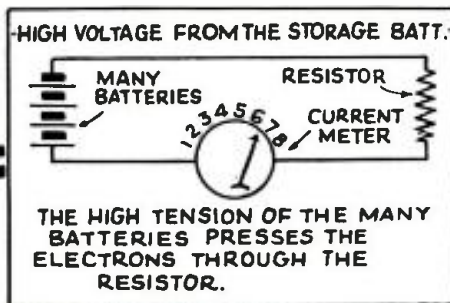
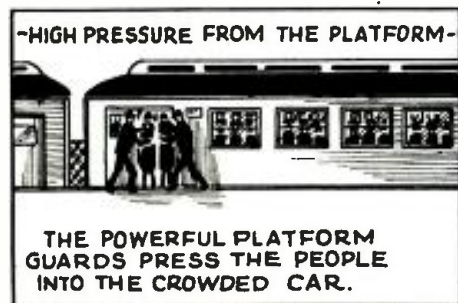
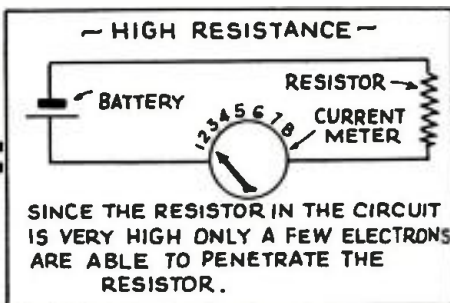
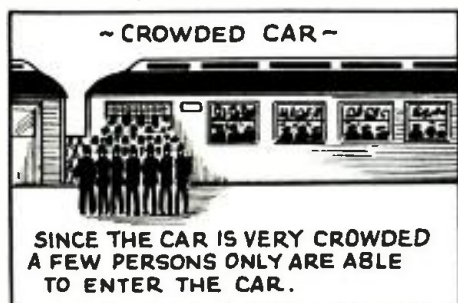

Fig. 2. The similarity of people crowding into a subway train and electrical circuit conditions is strikingly evident here.

in this paper, but can be better answered by the Queens of the Love-Lorn columns of our dailies. But without being indiscreet, we shall discuss the link which connects amber with modern electricity and just mention that a young Greek couple once upon a time found that such a piece of amber when rubbed acquired the secret power of attracting small pieces of wool, etc., an effect produced even today by schoolboys.

The Greeks called these yellow pieces of resin "electron," but they wrote the word in this way: Ηλεκτρον. The English scientist, William Gilbert, who studied the effects of frictional or static electricity produced by rubbing pieces of amber, announced (about 1600) this effect of attraction as a new power of nature not known until then. Sir William Gibert was a real scholar who also knew quite a bit about Greek and read each morning before breakfast about "The Travels of Ulysses" in the original language—Greek. In the 15th song, verses 114 et seq. of this famous story there is the word "electron" mentioned, as descriptive of the yellow amber, and this is the reason why we use the name *electricity* today for this very useful force of nature.

Fig. 1. The difference in pressure (voltage) is shown with a subway train simile.



DIMENSIONS FAR BELOW OUR HORIZON

Since Sir Gilbert christened this force "electricity"; and Benjamin Franklin flew a kite for the first time in a storm, our understanding about it has grown and grown, and despite the fact that even today no one has been able to see electricity, yet, modern science is able to tell us the weight of its most tiny particles which we call "electrons." These invisible bits of electricity weigh only 1/46 billion, billion, billion, billionth of an ounce, and are able to travel at speeds of thousands of miles per second.

A MAGICAL MAGNIFYING GLASS

Since electrons have dimensions far below our horizon of conception we shall take the liberty to put them under a magnifying glass, which, despite the fact that it exists only in our imagination, will help us to understand electricity and its behavior. This makes our conversa- (Continued on page 557)



HOW TO MAKE A "FREE-REFERENCE-POINT" RESISTANCE-CAPACITY ANALYZER

A companion unit for the Free-Reference-Point Analyzer described in the January, 1936, issue of *RADIO-CRAFT*.

W. C. BELLHEIMER

The appearance of the front panel.

THIS unit was developed for use in conjunction with the "Free-Reference-Point Analyzer," which appeared in January, 1936, *Radio-Craft*. The sensitive meter in that unit is utilized for resistance measurements. Two systems of analyzing are thus available from a single case or panel.

The built-in standards provide a resistance and capacity-bridge range of such proportions that it is unnecessary to use an external standard for any measurement in modern servicing.

The resistance across the neon bulb is used to decrease the sensitivity so that good condensers will not be condemned. The filter condenser must be connected as shown in the diagram, so that any leakage will not cause the neon bulb to glow.

The meter scale reproduction shows the ranges of resistance, while the bridge scale shows the ranges of resistance and capacity.

To find the No. 1 position on the bridge, connect two resistors of equal value, one to "EXT." and one to "TEST." Turn the pointer for least hum in the phones. Mark the panel, and reverse the two resistors. If the null point is the same, this is the No. 1 position. If there is a difference, the No. 1 position is the center of the two null points.

Following is a description of the operation of the tester:

TESTING CONDENSERS

Quality Test: Set Sw.3 to "LEAK" and Sw.2 to "NEON." Set Sw.1 to "A.C." and Sw.4 to "C." Switch Sw.5 should be set to "EXT." for this test. When the "EXT." jacks are open, this is an off position for Sw.5, with the exception of the ohmmeter. The condenser to be tested is connected across the "TEST" jacks. A good mica or paper condenser will flash the neon *once*. A steady, *bright* glow indicates a shorted condenser. A steady, *dim* glow indicates a high-resistance leak. A fast, intermittent *flash* indicates a leaky unit, while *no flash* shows the condenser to be open.

For an electrolytic condenser, the polarity markings

must be followed. For a good unit, the neon bulb will light, and fade out in about 15 seconds. One having low leakage will cause the neon to glow dimly. This does not necessarily mean a defective unit. A steady, bright glow indicates a short-circuit, while no flash indicates an open-circuit.

Value Test: To check the value of a paper or mica condenser, connect it to the "TEST" jacks. Set Sw.1 to "A.C.," Sw.2 to open, Sw.3 to "OHMS" and Sw.4 to "CAP." Set Sw.5 to the position which includes the approximate value of the unknown unit. (If this is not known, several positions must be tried.) When the Bridge-scale knob is rotated until minimum hum is heard in the phones, the pointer then indicates the value.

For electrolytic units, Sw.3 is set to "LEAK" and all other controls are identical to the above.

RESISTANCE MEASUREMENTS

Meter Test: Connect "METER" jacks to the Analyzer-meter jacks. For the low range, set Sw.5 at "EXT.," all other switches remaining off. Short the "TEST" jacks with a piece of wire. Clip the test leads to the "METER" jacks. This is a shunt position. The meter should be adjusted to full-scale with the "OHMS" knob before any measurements are made.

For the medium range, proceed as above, except that the test leads are plugged into the (Continued on page 556)

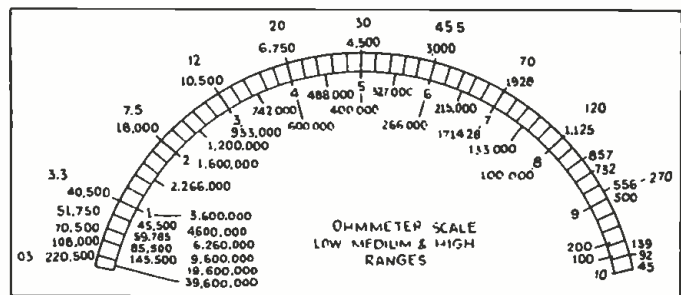

The low, medium and high ranges of the ohmmeter part of the unit.

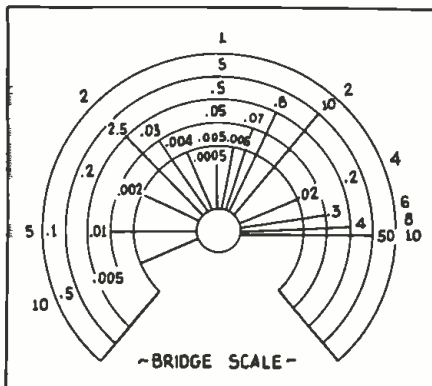

Left. The scale for bridge measurements in which resistors and condensers are tested. Right. The circuit of the Resistance-Capacity Analyzer, showing connections and values.

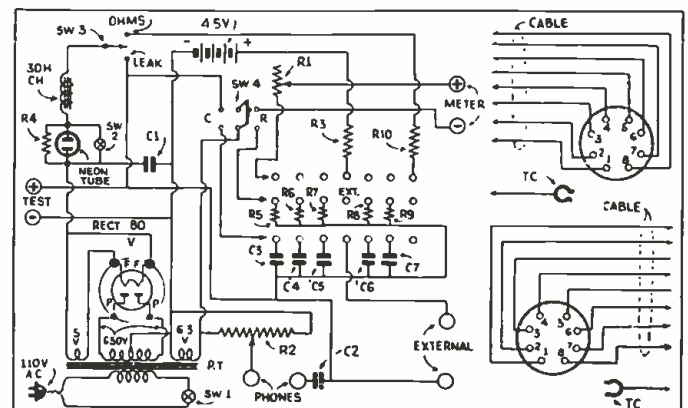

AWARDS IN THE CONTEST	
FIRST PRIZE	\$10.00
SECOND PRIZE	5.00
THIRD PRIZE	5.00
Honorable Mention	

USEFUL CIRCUIT IDEAS

Experimenters: Here is your Opportunity to win a prize for your pet circuit idea, if it is new, novel and useful.

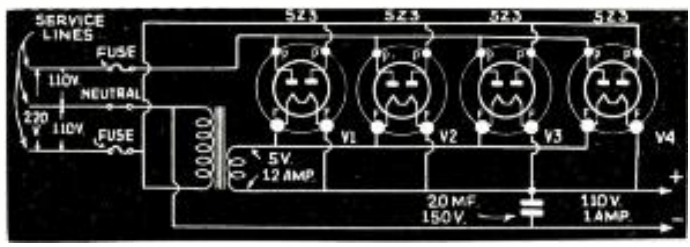

Fig. 1. A heavy-duty, inexpensive D. C. supply for use in A. C. power districts.

FIRST PRIZE—\$10.00

DIRECT CURRENT SUPPLY. Many uses may be found around the shop for a supply of direct current of about 110 V. at 1 A. Most Service Men are located in A.C. districts, however, and have no access to such a supply.

The circuit shown in Fig. 1 is the answer to this problem and the cost is very low. It has been used to test 110 V. D.C. sets, to excite speaker fields, to charge high-voltage storage batteries, and for many similar purposes.

Since I have a 220 V. 3-wire circuit, I use the neutral wire as the center-tap (as in any common full-wave rectifier circuit). A filament transformer which can supply 5 V. at 12 A. lights the filaments of the 4, type 5Z3 tubes. The whole equipment may be mounted in a compact unit.

RODNEY E. REED

SECOND PRIZE—\$5.00

SILENT TESTING OF "INTERMITTENT" RECEIVERS. Often an intermittently-operating set must be put on test and allowed to run for hours at a time so that the repair man can work on it as soon as it goes out of action. Several such sets in operation in one shop make it almost impossible to do any work because of the noise. After enduring this for some time, I hooked up neon bulbs to the output stages as shown in Fig. 2, and opened the voice coil circuit to silence the set. When tuned to a fairly loud station, the bulb will flash continuously with the audio signal, so that it is immediately apparent when the set stops operating.

HARRY E. WESSEL

THIRD PRIZE—\$5.00

A N. A. F. OSCILLATOR. Many Service Men have modulated oscillators on which no provision is made for using the A.F. modulation separately. A simple way of doing this is shown in Fig. 3. The modulated R.F. output is rectified by the crystal detector, which preferably

should be of the fixed type. When the ordinary R.F. output is desired the shorting switch is closed to cut out the detector.

In setting up this circuit modification, it must be remembered that long leads from the shorting switch may slightly effect the R.F. alignment of the oscillator.

LESLIE E. PUGH

HONORABLE MENTION

REGENERATION CONTROL. By connecting in series with the usual potentiometer, a potentiometer 25 times smaller in resistance value, as shown in Fig. 4, very smooth and fine regeneration control may be had. This will be readily understood, because the arm of the low-value control moves 25 times as far as the arm of the main control to cause the same amount of circuit change.

MARVIN LOFTNESS

HONORABLE MENTION

REMOTE VOLUME CONTROL. It is very handy to have a remote control for the radio receiver situated at the telephone or any other point, so that the control on the set may be cut out at will and the remote control substituted. This is easily done by the use of the circuit in Fig. 5. A volume control of the same type as that used on the set is needed, as well as a D.P.D.T. switch (to select either volume control).

QUENTIN ACHZEHNER

HONORABLE MENTION

SMOOTH REGENERATION CONTROL. By means of the circuit of Fig. 6, a very smooth and stable control of regeneration may be obtained. (I believe this idea to be an improvement over the one shown in this department of the December, 1935, issue, which I found to be noisy and critical.) The size of the condenser depends on the position of the tap on the tuning coil. I use a 110 mmf. condenser.

WESLEY W. HARRIS

HONORABLE MENTION

PHONO OSCILLATOR. This simple unit, the diagram of which is shown in Fig. 7, may be used to reproduce recorded material through any radio receiver, thus utilizing the full amplification of the receiver. It does not actually have to be attached to the set, but can be placed up to 25 ft. or so away from the receiver and the signal picked up over the regular antenna. Coil L and condenser C are standard units that tune within the wavelength range of the set. (If the unit should cause any interference to other set owners—in the same building, for instance—it must be thoroughly shielded, and coupled to the set via a shielded line.)

FREEMAN R. TUPPER, JR.

HONORABLE MENTION

LOW-TUBE CONDENSER TESTER. The unit, the circuit of which is shown in Fig. 8, is made up from a "B" voltae supply and a type 374 "gas filled voltage regulator," or glow tube. A shorted condenser will cause the glow to go out, while a leaky condenser will cause flashes. If a current of more than 45 ma. is drawn at the 90 V. tap, the tube will "go out." The "B" supply may be an ordinary "B" eliminator.

L. J. MANGUSO

HONORABLE MENTION

"GRID-DIP" TEST OF SMALL CONDENSERS. It is often necessary to find the value of small fixed condensers (of less capacity than C1) which are not clearly marked as to capacity. By using the scheme outlined in Fig. 9, this may be done easily and quickly. An ordinary grid-dip oscillator is used in conjunction with a condenser and coil combination. C2-L2. Condenser C2 is set so that the tuning condenser, C1, must be turned almost fully open before the meter dips. The unknown condenser, Cx, is then connected across C2, and C1 turned until the dip occurs. The readings of C1 may be charted on graph paper against capacity, the settings being obtained by the use of known capacities.

R. RADFORD
New Zealand

HONORABLE MENTION

HOME-MADE VIBRATOR—"B" ELIMINATOR. This "B" eliminator was built out of spare parts found around the shop and has

(Continued on page 553)

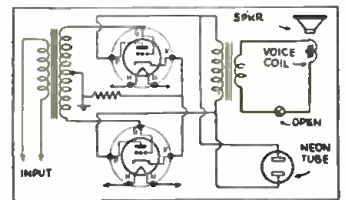

Fig. 2. Testing sets quietly.

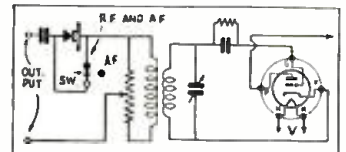

Fig. 3. Audio oscillator.

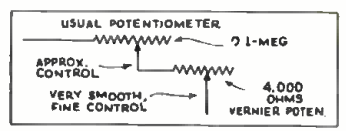

Fig. 4. Vernier regeneration.

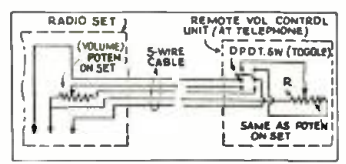

Fig. 5. Remote volume control.

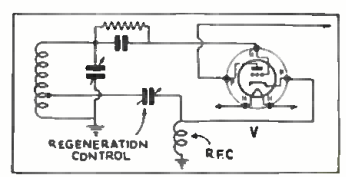

Fig. 6. Smooth regeneration.

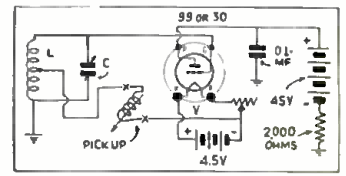

Fig. 7. Phono oscillator.

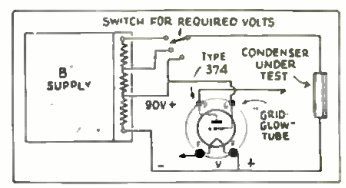

Fig. 8. Condenser "worth" tester.

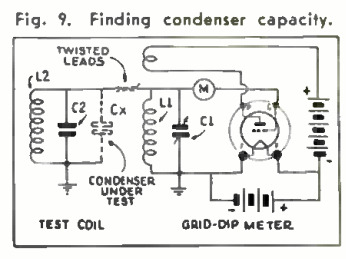

Fig. 9. Finding condenser capacity.

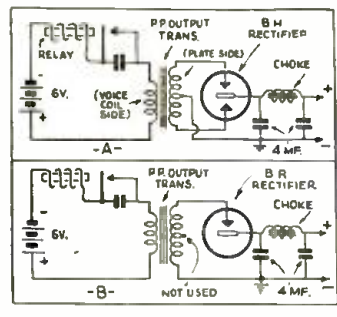
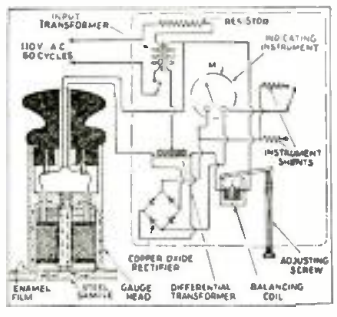
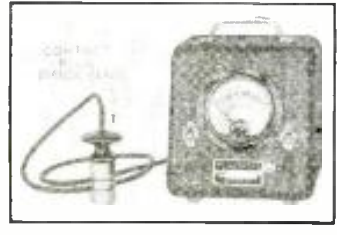
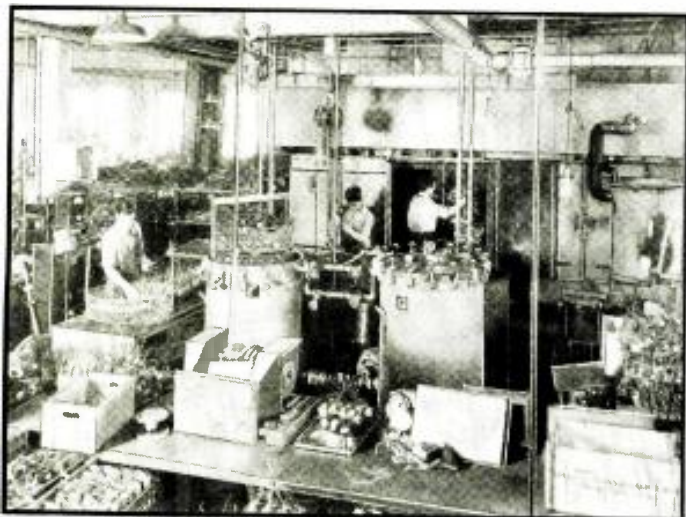

Fig. 10, left. Plate supply from 6 V. Fig. 11, below. Thickness gauge. Fig. 12, right. Circuit of same.





"PULL-PUSH" MOISTURE-PROOFING FOR TRANSFORMERS

The use of transformers in tropical climates necessitates complete moisture-proofing.

C. E. DE HORN

AN OUTSTANDING development in radio manufacture for international trade is the new "Pull-push" process of moisture-proofing coils used in power supply units. This is especially advantageous for radio sets in the tropical climates far distant from the manufacturing source of supply, where it is difficult to obtain replacement parts and where there is insufficient trade to warrant the installation of adequate equipment for properly moisture-proofing repaired units.

In addition to accurate electrical characteristics required of transformers to produce the highest quality performance, and to assure continued proper service it is absolutely necessary to so thoroughly seal the coils that moisture does not penetrate the insulation between the wires and thus short-circuit the unit.

This moisture proofing sealing compound must be of such

consistency that it does not soften and drip out of the coil from the normal temperature rise during continued use in the hottest climate, for this would permit moisture to enter in humid weather, thus causing burn outs.

In the background of the heading illustration are shown a bank of "dehydrating" (moisture-removing) ovens—first step in "pull-push" impregnation. Tray upon tray of the raw coils is here pre-heated for a sufficient period to evaporate the moisture—the degree of vacuum and compression, the time, and heat depending upon the size and structure of the coils.

On the post at the left is shown the electrically operated temperature control which provides an instantaneous and accurate check on the heat level of all ovens and all impregnating tanks.

Immediately in back of tank F is shown a high-vacuum pump which pulls all air and moisture from the impregnating tanks F and G, alternately, when loaded with coils, thus providing a perfectly dry chamber for the hot, special 9X, moisture-proofing wax to enter. The wax is then forced into the coils under heavy compression.

Impregnating tank G at the (Continued on page 551)

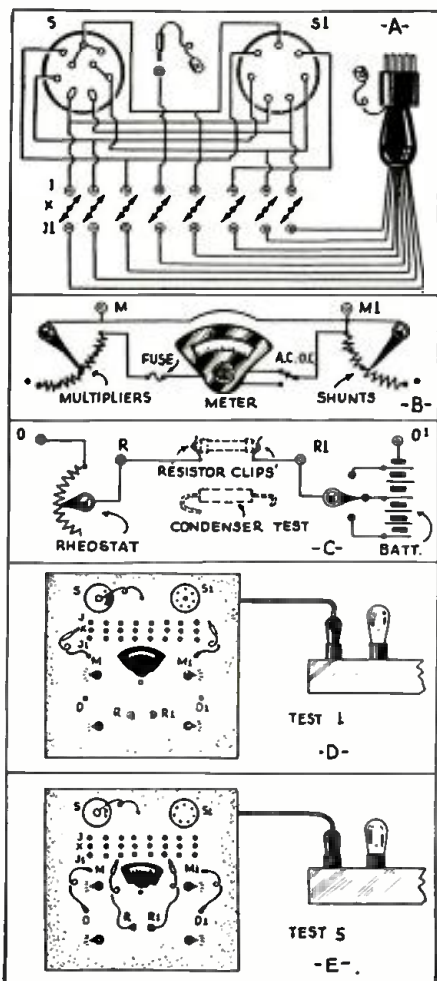

A BEGINNER'S SECTIONAL TEST PANEL

Here is a tester for the beginner in servicing—it can be expanded as funds and knowledge permit—for all tests.

E. J. MADDEN

"WHERE can I borrow a meter to measure that value?"

This is one of the most frequently heard questions, among radio set builders and experimenters. Everybody can't afford to buy a regular service tester, even on the "instalment plan," but you can build one on the "sectional plan" outlined below. The picture shows a very good modern tester built on this plan by boys pooling only 10c per week apiece, at a total cost of \$18.20! The whole assembly may look complicated and discouraging at first, but when it is broken down as here described the units are found to be easy to make, wire, and use.

This instrument combines the functions of A.C. and D.C. voltmeter, milliammeter, ohmmeter, capacity meter, output meter, tube tester, and circuit analyzer, in a special flexible circuit permitting endless adapt-

ations. By means of the bank of series switches, X, the meter may be connected in parallel or series with any element of the set, and at the same time a resistor or battery or condenser cut in at any other point, while the set is in operation. This makes it a simple matter to test by comparison or substitution, and provides means for changing values to take readings for performance curves.

To build this (Continued on page 558)

The front and back views of the tester panel.

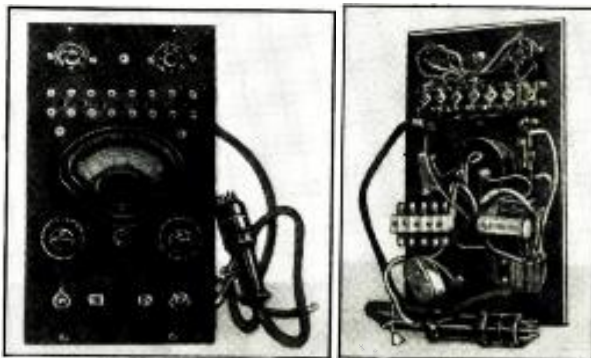

A "MAGIC-EYE" LEAKAGE-TESTER

This inexpensive precision tester for the experimenter, Service Man or novice takes the place of neon leakage testers and does a better job.

C. T. NICHOLSON

WITH THE advent of wide-range A.V.C. and kindred circuits involving high resistances and the associated small bypass condensers, the all-important service ohmmeter was supplemented by some sort of leakage indicator, usually a high-voltage circuit incorporating a neon glow-tube or other indefinite form of indication. Unfortunately, the use of this high test voltage has probably ruined as many low-voltage bypass condensers as the number of faulty units it has helped locate! The need of a sensitive low-voltage test circuit has been felt for some time but due to the high cost and delicacy of a very low-reading microammeter (100 microamperes, or less) most experimenters and Service Men have put up with the dangers of high-voltage tests.

THE NEED FOR HIGH-OHM TESTS

The introduction of the 6E5 cathode-ray tuning indicator tube which was described fully in December, 1935, *Radio-Craft* makes possible many new test devices; the one described here will undoubtedly be used to replace the unsatisfactory high-voltage tests for the determination of high resistance values and the location of current leakage. This unit has been used to measure leakages in tubes as high as 80 megohms. True, the usual service problem does not involve such tests, but in comparing condensers for use as grid blocking condensers it is a great advantage to know that the 250 V. circuit of the preceding plate is not undoing the normal biasing of the grid in question!

The unit shown in the accompanying schematic diagram and photographs will make measurements of resistance or leakage in an extremely efficient and accurate manner. The accuracy, of course, depends on the care with which the calibrated scale is made and in some measure on the condition of the grid circuit bucking battery. The longtime accuracy can be improved by inserting a small D.C. voltmeter and high-resistance potentiometer in this battery circuit to allow occasional adjustment of the battery voltage. This refinement is not usually warranted because of the added switches and adjustments as well as the shortened life of the bucking battery.

FUNDAMENTAL CIRCUIT

The basic circuit of the tester in Fig. 1 includes a source of 250 V. D.C. for operation of the cathode-ray tube. The high-voltage supply incorporating transformer P.T., rectifier tube V2, filter choke Ch., filter condensers C1 and C2, and bleeder resistor R2 may be dispensed with in an analysis of the operation of the tester or in the use of the tester as part of an apparatus which already has a "B" supply incorporated.

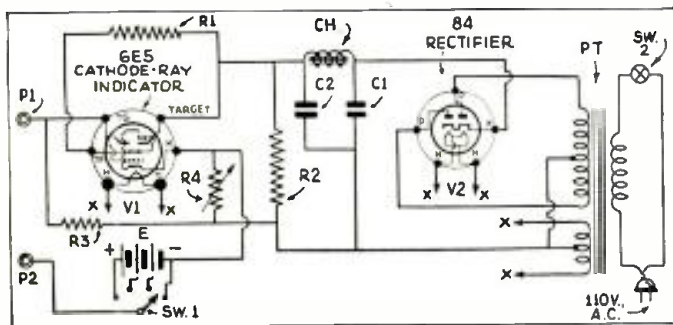

The operation of the cathode-ray tube for the measurement of resistance is not unlike the very familiar vacuum-tube voltmeter method of measuring resistances which has been featured many times in the past. The prime difference is in the unique use of the cathode-ray tuning indicator to replace not only the milliammeter of the voltmeter but also the triode.

In operation the 50,000-ohm variable resistor, R4, supplies the normal 8 V. negative bias to the control-grid of the 6E5 through the 1. meg. gridleak R3; this normal bias causes the ray screen to be completely luminous. This normal bias is reduced by virtue of the positive component of voltage present on the grid when some resistance is inserted between binding posts P1 and P2. A reduction in bias causes the formation of a dark sector on the luminous screen; the greater the reduction in bias the greater the size of the sector up to zero bias. A scale placed over the tube top permits the use of this sector variation as an accurate index of the resistance value between posts P1 and P2.

The range of the circuit may be changed by having taps on the bucking battery, E. If the battery, E, is removed from the circuit, the useful range of the instrument will be approximately between 0.1-meg. and 2 megs. If a 1.5 V. battery is used the useful range will be from .25-meg. to 5.0 megs. If a battery of 15 V. is used, the useful range will be from 2.5 to 50 megs.

VARIOUS USES

So much for the fundamental circuit of the tester. Its use for resistance or leakage measurements is readily self-evident except that resistor R4 is variable to permit a (Continued on page 559)



Fig. A, top-right. Exterior appearance of unit.

Fig. 1, left. The circuit of the tester and power supply for A. C. operation. The devices to be tested are connected to P1 and P2.

Fig. B, right. The interior of the tester showing how the 6E5 tube is mounted on the panel.

THE LISTENING POST FOR ALL-WAVE DX-ERS

C. A. MORRISON



The broadcast station at Riobamba, Ecuador, which transmits on 6,618 kc. with 2,000 W. power.

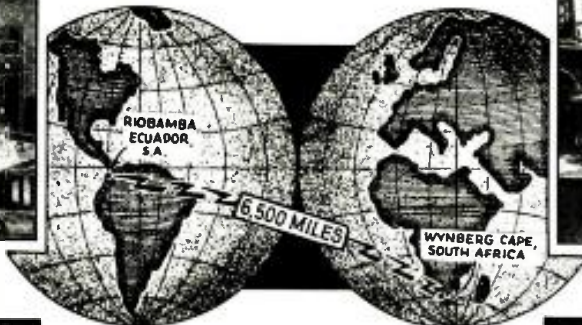

The listening post of Eric Ireland at Wynberg Cape, near Capetown, South Africa.

THE ALL-WAVE DX-er always eager for new stations to snare will soon find an entirely new field of DX open for conquest. This is the most fascinating and interesting of any radio channels yet opened for broadcasting purposes because of its unknown, but potential possibilities. This new DX region lies still higher in frequency than the 28-megacycle (10 meter) amateur band, which itself is daily becoming more and more popular. A rush for experimental broadcast licenses on these *ultra-high frequencies* has already started and this promises to be one of the most active of any of the short-wave channels in the future.

The *St. Louis Post Dispatch*, pioneer owners of KSD, St. Louis, have a new short-wave experimental broadcast station W9XPD on the air on 31.6 mc. (or 9.5 meters). This station is of the high-fidelity type, and although having only 100 W. of power has already been reported in all parts of North America. Station W9XPD is relaying broadcast station KSD daily on an irregular schedule. The *St. Louis Star Times* has an ultra-short-wave station which will soon be broadcasting under the call W9XHZ.

The Columbia Broadcasting System also is experimenting on the ultra-high-frequencies with the inauguration of their short-wave station W2XDV, which is operating on a frequency of 35.6 mc., or 8.43 meters. Station W2XDV is located at CBS headquarters, right in

the midst of New York's great steel structures. Station W2XDV relays the WABC network daily from 5:00-10:00 pm E. S. T. This transmitter is also licensed to operate on 41 mc., 86 mc., and eventually on 400 mc. (or less than 0.75-meter). The frequency of this last-named channel is quasi-optical in its nature, and must wait until proper tubes and receiving equipment have been developed.

Short-wave listeners who have receiving sets tuning to these new channels can help to a great extent in developing this new region by carefully noting reception conditions, and attendant phenomena of such stations as are heard.

THE MOST POWERFUL S.A. STATION

Station LR1, Radio El Mundo, Buenos Aires, Argentina took the air the middle of November, 1935. Details concerning this super-power station of the Southern Hemisphere are furnished to *Radio-Craft* readers in an exclusive air-mail communication from Senor Enrique del Ponte, General Manager of the new station.

Radio "El Mundo" broadcasts on a frequency of 1,070 kc., with a power of 50,000 W. (maximum available, 75,000 W.). The transmitter of LR1 is located at San Fernando, F.C.C.A., province of Buenos Aires on a plot of 40,000 sq. meters (yards, roughly) of ground especially selected for its "ra-

dio" location. The transmitting towers are each nearly 500 ft. in height.

The studios of LR1 are located at Calle Maipu 555, in the heart of the city, and are probably the most unique in the world. Dr. W. R. G. Baker, Vice-President of RCA, upon visiting this station, said that by virtue of its equipment, potentiality, and studios, it has no rival throughout the world. There are 8 studios at LR1, equipped with all the latest devices of modern science.

Station LR1 will carry only the highest-grade commercial programs, and under *no* circumstances will *spot* announcements be permitted! The finest entertainment acts in Argentina have already been lined up for LR1 broadcasts, and in many cases leading acts have been secured from Europe and America especially to grace the microphones of this amazing station LR1. The main studio of LR1 has been built as the specific home of a special program. The two-story concert studio is capable of holding an orchestra of from 100 to 300 musicians and will accommodate the Symphony Orchestra of Buenos Aires under the baton of Maestro Juan Jose Castro.

As a proof of the great carrying power of LR1 transmissions we ask DX-ers to carefully note the Spanish station that (*Continued on page 560*)



At left and right are shown two views of the Budapest broadcast station. The transmitter panel (left) is unique with its modernistic simplicity. The entire transmitter is controlled from the master monitoring desk in the right foreground. The antenna (right) is a half-wave radiator.

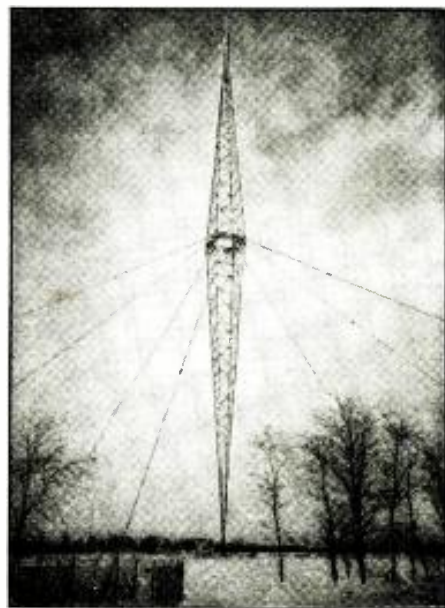

AN ALL-WAVE ADAPTER FOR OLD SETS

This "preselector-converter-amplifier" makes an all-wave set out of broadcast-band receivers.

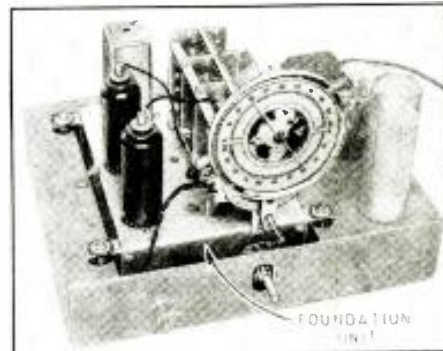

HERETOFORE it has been customary to consider the short-wave or all-wave converter as an adjunct to the regular broadcast receiver only at wavelength below 200 meters; or, in a few instances, as a device for operation up to 550 meters but with a band skip frequency usually around 200 meters, to provide for the intermediate frequency adjustment. The new device here illustrated and described however is of exceptional interest due to the fact that complete wavelength coverage is obtained as a

converter on wavelengths on 550 meters down to 16 meters. In addition, this new unit affords additional selectivity and volume on the regular broadcast band.

As the photo and schematic circuit indicate, there are only 3 tubes in this unit, two of which are of the metal-glass type; full-steel tubes may be substituted for the latter 2 tubes, but it is inadvisable to attempt to make this change without realigning the unit for the particular tubes used.

Known as a preselector-converter-

amplifier or "P.C.A." instrument, this device includes its own power supply and consequently to put it into operation the only procedure is to plug the P.C.A. unit into the power line, connect its output terminal to the antenna post of the broadcast receiver, and swing the antenna of the broadcast receiver to the antenna post of the P.C.A. unit. (Terminals are provided for a doublet antenna; otherwise, the second antenna terminal straps to the ground terminal—which may or may not be grounded, as required.)

Many broadcast receivers when operated at the peak adjustment for maximum sensitivity become exceedingly unstable. This condition is overcome by the use of a P.C.A. unit. For instance, with an average receiver adjusted for a sensitivity not exceeding about 100 microvolts-per-meter, the condition of circuit instability is remote; now, with (Continued on page 559)

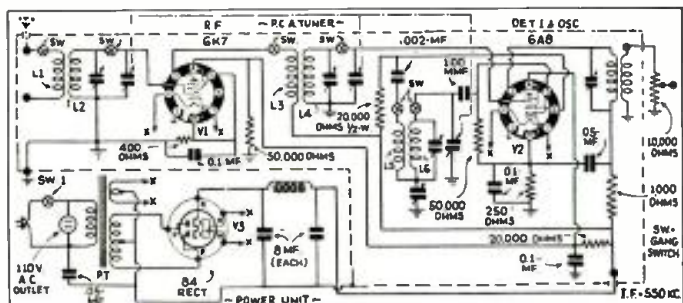

The circuit of complete P. C. A. unit. The tuner, shown within dotted lines, is connected to the additional parts to make up the complete P. C. A. unit.

HIGHER FIDELITY FOR EVERYONE

A simple change in the A.F. amplifier improves quality. ARCHIBALD J. BELL

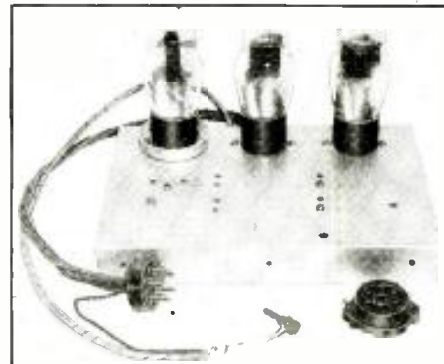

The appearance of the amplifier.

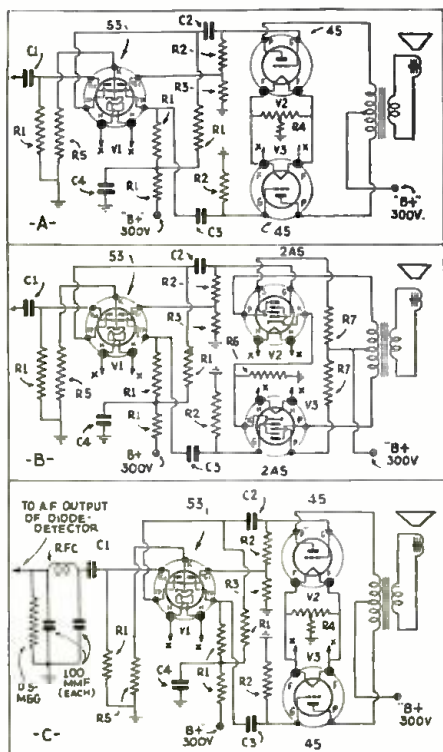

THE term "high fidelity" applies not only to faithful response in the treble range, up to about 7,500 cycles (R.M.A.), but also applies with equal force to frequencies from 2,000 down to 40 cycles, where the real distortion has occurred; (due to transformer characteristics, and cabinet resonance effects).

The author offers in Fig. 1 (at left) a design which reproduces music and voice with A1 fidelity. It consists of a 53 (or 6A6) tube as A.F. amplifier and phase-inverter feeding a pair of 45s in class A push-pull. Resistance coupling is used and the push-pull action brings out the life-like tone of the more modern broadcast stations.

VARIOUS CIRCUIT APPLICATIONS

The circuit at Fig. 1A will replace the majority of receivers having a 27 feeding two 45s through an input transformer. In older sets where a 27 feeds two 12As or 71As, the 53 is operated on the 27 filament winding and the 12As or 71As retained. In receivers with type 26 A.F. tubes, a small 2.5 V. transformer can be added to light the

filament of the 53 and the 45s (which will replace the former tubes). This circuit will also cover installations with 2A3s, provided the receiver was originally designed for them.

The circuit in Fig. 1B will replace receivers made since 1932 with pentode output; however in sets where types 55, 85 or 2B7s feed a single or push-pull pentode, the input condenser C1 may go to the diode load resistor directly, cutting out the triode section of these tubes which might give too much gain with this amplifier. It may be feasible to try this amplifier with the triode sections first. The 2,000 ohm resistors in the pentode screen-grid leads prevent circuit oscillation, especially where high-quality output transformers are used.

The circuit in Fig. 1C is for receivers which have (Continued on page 561)

MAKING A 12-TUBE HIGH-FIDELITY BROADCAST RECEIVER

Here is a real high-fidelity set solely for superior reception of local stations on the broadcast band.

M. H. GERNSBACK

PART II—POWER SYSTEM

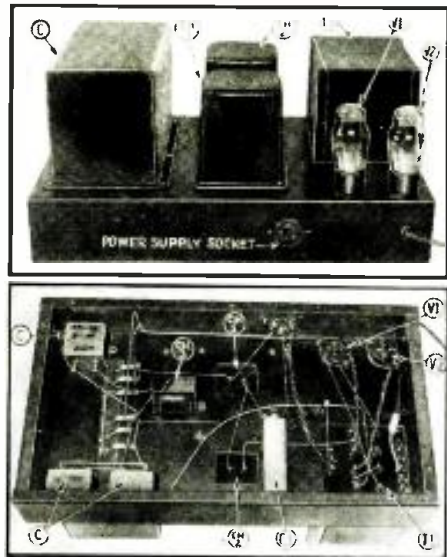

THE POWER SUPPLY unit for this receiver (the Tuner of which was described in the preceding issue) was the subject of much thought before the final design, described here, was evolved. The following qualifications were deemed essential for such a unit.

First, the filtering had to be exceptionally good in order to reduce background noise in the receiver to a very low level for high-fidelity reproduction. Second, the internal resistance of the plate supply had to be as low as possible to insure an unvarying source of current even at high-volume levels in order to keep harmonic distortion at a low value. Finally in order to minimize servicing problems the particular components indicated in the List of Parts were selected.

TECHNICAL DETAILS OF POWER PACK

The power supply unit employs 2 rectifier tubes, a type 83V, and a 45 with plate and grid tied together, as shown in Fig. 3. The 83V, because of its low internal resistance and consequent low voltage drop even with heavy current drain, is used as the main "B" supply rectifier. Its "choke input" arrangement (as against "condenser input," utilizing a 4 mf. unit), improves the "regulation" of the power supply. That is, the output voltage does not vary greatly, even with large changes in the amount of current drain. The type 45 is used only as a bias rectifier for supplying "C" bias voltage for the power stage of the receiver. Here, condenser input is employed, since voltage regulation is unimportant (the current drain is fixed at 2 ma. by the value of the voltage divider across the bias source).

A more flexible arrangement of the power transformer than as shown in Fig. 3 would be to have 2 separate 6.3 V. windings, one for 3 A. (the two power tubes) and the other for 4 or 5 A. (for the remaining tubes). The power transformer should be cased in a heavy shield to prevent stray magnetic pick-up by the receiver. It should also contain an electrostatic shield between the primary and secondary to reduce line-noise pick-up. The two 10-hy. chokes are thoroughly shielded heavy-duty units. The D.C. resistance of each should be 160 ohms, or less, with rated inductance at the full operating current drain of 160 ma. (a "10 hy." choke rated only to carry 160 ma. without burning out would have an A.C. inductance of only about 1 hy.).

The 4 and 8 mf. filter condensers in the high-voltage circuit should be rated at 500 V. (or higher) working voltage to insure against breakdown in service.

ADJUSTMENT OF THE TUNER BY MEANS OF THE VISUAL INDICATOR

The set should be turned on and the volume control turned up. The R.F. trimmer condensers (in shunt to the respective tuning condensers, but not shown in Fig. 1) are of air-tuned type to insure permanence of alignment. These units, which are mounted in such way that the ad-

justment screws project through the top of the chassis, should be set at about $\frac{1}{3}$ full capacity.

Now tune the set to a station carrier or service oscillator signal at about 1,400 kc.; at resonance, the cathode-ray tuning indicator beam should narrow. Now adjust the trimmers, starting with the antenna unit, until the tuning beam is least narrow. Repeat this procedure at a 600 kc. (approx.) setting of the receiver. With a matched set of coils the position of each trimmer should be almost identical and very little change in adjustment should be necessary at 600 kc. as compared with 1,400 kc.

ADJUSTING THE BASS BOOSTER

On the diagram of the tuner there are two dual potentiometers indicated in the bass-booster circuit; one unit has a resistance of .5-meg. per section, and the other, .25-meg. per section. The .25-meg. control is mounted under the chassis and once adjusted is left fixed.

The .5-meg. unit is controlled by a knob on the front of the panel, and is used to vary the degree of bass boosting. To adjust the bass-booster circuit, turn the main volume control to the off position and turn up the bass-booster control to the full-on position. Next adjust the .25-meg. control for maximum resistance. In this condition a low-pitched motorboating or purring should be heard from the reproducer. Finally, adjust the .25-meg. control until this sound just disappears.

SPEAKERS

It is essential, in order to do justice to this receiver, to employ an adequate reproducer system. The particular set-up employed by the author made use of 2 speakers, one a dynamic-type "tweeter," and the other a dynamic-type bass speaker, with a dividing filter network to supply only "highs" to the tweeter and "lows" to the bass speaker. However, a single, high-fidelity type dynamic reproducer in this radio set should give much better reproduction than it would in the average set, although a tweeter of the dynamic or crystal type is recommended.

The power transformer has a tapped primary winding enabling adjustment for proper line voltages from 100 to 125 at 60 cycles. The total power consumption of the set is about 100 W. The high-voltage secondary must be able of supplying 310 V. under a load of 175 ma.

(Continued on page 555)

Fig. 3. Circuit of the power supply unit. Note the separate rectifier for power-tube bias.

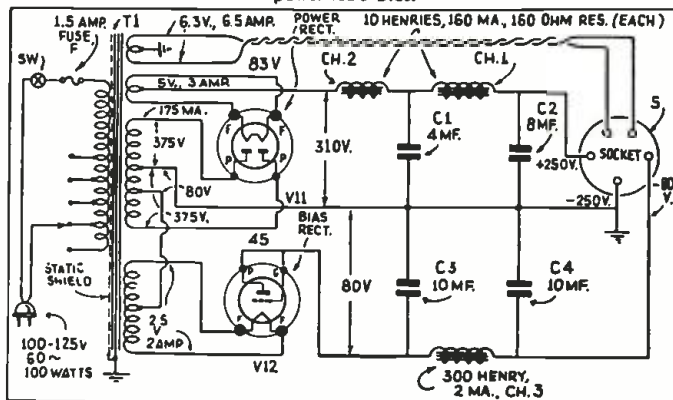

NEW HINTS ON ELIMINATING INTERFERENCE

Methods for eliminating traffic-light noises.

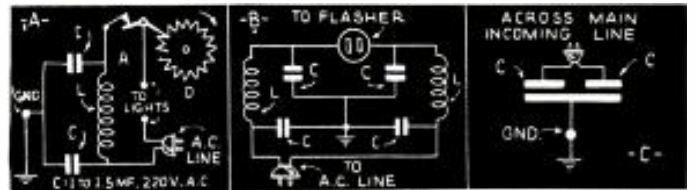

Fig. 1. At A is shown the most simple form of filter, connected to a blinker light flasher. At B is a more efficient form of filter circuit, and at C is a third form. Article contains coil construction data and condenser values.

TRAFFIC SIGNALS are a source of prolific interference to radio reception and until legislation is enacted prohibiting the operation of improperly shielded and filtered interference generating equipment, it is incumbent upon the Service Man to mitigate the condition by installing filter equipment at the source of the interference or at the radio receiver. A new idea in test equipment, an "adjustable analyzer" (see the item "Interference Analyzer," October, 1935 *Radio-Craft*, page 216), makes it convenient for the Service Man to determine requisite filter capacities in various types of such filter circuits; 3 fundamental diagrams of this nature are shown in Fig. 1.

At A is shown one type of contactor in the yellow caution light or blinker (flasher) usually installed at minor traffic intersections in residential districts, and which ordinarily is the worst offender (red and green lights operating at regular 10 to 30 second intervals do not often cause serious interference).

In this illustration, D is a saw-tooth disc operated by a small motor; A, the contacts in series with the flasher lights; L, an R.F. choke coil consisting of approximately 1/2-lb. of No. 18 bell wire (up to a 5 A. circuit); and C,—all of one value. More obstinate cases of traffic light interference are corrected by the use of circuit B; or, as a last resort, this filter set-up plus the arrangement shown at C. Combinations A-C, or B-C will solve all ordinary problems of interference from this source.

Once having determined the correct filter combination, as indicated by the setting on the interference analyzer, the requisite components may be installed directly in the signal box, or a metal container may be fastened on the outside, as required. (The traffic light maintenance crew will often supply and mount such a container for you.)

A car-radio set in operation fairly close to the control box is an excellent aid in determining the best filter adjustment.

Radio interference from traffic signals is a common cause of disturbance on both home and automobile radio receivers. Generally, however, nothing is done about it largely because people who are bothered with this type of interference either do not know where it comes from, or, if they do, they assume that it cannot be eliminated. Even Service Men have hesitated to approach the problem for lack of a definite plan for going after this business.

On the other hand, my own personal experience as a Service Man has convinced me that there is a profitable field here for the fellows who will go after it. Just as they did in my town, many city officials will be glad to cooperate if you go to the trouble of explaining the matter carefully and even demonstrating how much radio interference an innocent-looking traffic light can actually cause. With the number of lights now used in the average town or city, I hardly have to point out what a juicy slice of (Continued on page 558)

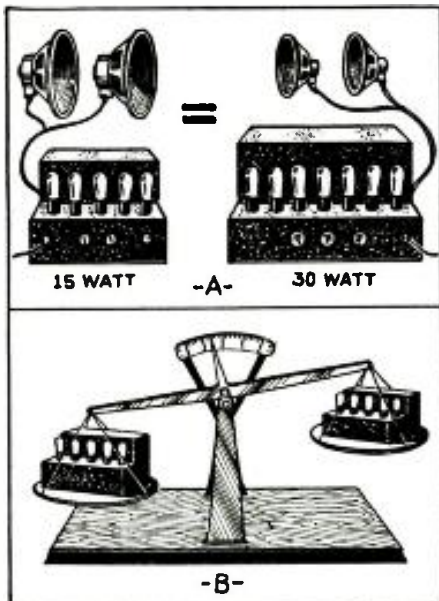

Good speakers are more important than large amplifiers (see upper illustration) and a heavy unit having plenty of transformer core iron is better than a light one (lower sketch).

ALTHOUGH practically all the people engaged in public address work come from the radio field, the possession of technical knowledge and experience alone is no guarantee that a successful radio Service Man or experimenter will also be a successful P. A. specialist. Too many men enter the business with a casual attitude of complete self-assurance, expressed somewhat in this fashion:

"Oh!, P.A. consists of nothing but an

WHAT THE P.A. BEGINNER SHOULD KNOW

The beginner will find that there's more to Public Address than just an amplifier and a couple of reproducers. The author points the way for beginners in learning the business.

HUBERT L. SHORTT

A.F. amplifier with a mike and a couple of loudspeakers. That's a cinch for anybody who's wrestled with an all-wave superhet."

There is plenty of money being made and to be made in P.A., but the "beginner" (even though he is an old-timer as far as radio is concerned) must realize that both the merchandising and the technical problems are markedly different from those of radio selling or servicing. If he does realize this fact at the start, he will avoid many disappointments.

In radio sales or service, the tradesman must wait for customers to appear at his store or call him on the telephone. There is comparatively little opportunity for aggressive outside "selling." For instance, you can't make money out of a service job unless a radio receiver first goes bad, and that's something beyond your own control. In public address, however, 95 per cent of any P.A. man's business is obtained through direct solicitation of carefully selected prospects. The successful P.A.

man is primarily a salesman, a convincing talker who can "sell" owners of dance halls, skating rinks, airports, meeting rooms, theatres, picnic grounds, etc., on the desirability of P.A. equipment as a means of promoting their own business. Once the idea has been sold, the installation of the apparatus is a more or less routine job.

ACQUIRING A "FRONT"

The ability to figure costs accurately is another important requisite. An amplifier with a brace of loudspeakers is no cure for bad acoustics in a room or hall that was designed for pleasing appearance rather than effective sound distribution. The P.A. man should read up on acoustics (an excellent book on the subject is "Practical Acoustics for the Constructor," by C. W. Glover, *Sherwood Press*); also, he must know exact costs of amplifiers, mikes, speakers, wire, tubes, hardware, labor and his own time, and incidentally should investigate his prospect's financial status before he (Continued on page 565)

RADIO-CRAFT'S INFORMATION BUREAU

P.A. QUESTIONS & ANSWERS

Conducted by
CHARLES R. SHAW

Here is a new department for the Radio Dealer, Service Man and Sound Technician who require general information and help in P.A. work. This department will furnish valuable aid for the asking. Address all questions to *Radio-Craft's* Public Address Forum. Only those questions of general interest will be published and we reserve the right to publish any of these inquiries and answers.

SPECIAL NOTICE

Those questions which are found to represent the greatest general interest will be published here, to the extent that space permits. (At least 5 weeks must elapse between the receipt of a question and the appearance of its answer here.) Mark such inquiries, "For Publication."

Replies, magazines, etc., cannot be sent C.O.D. Back issues of *RADIO-CRAFT* prior to December, 1932, are available at 50c per copy; except the following issues: 7/29, 1, 2, 3, 4, 6, 7, 9 and 11/30; 5, 8 and 9/31; and 7/33, which are out of print. Succeeding issues are still available at the regular price of 25c per copy.

Inquiries to be answered by mail MUST be accompanied by 25c (stamps) for each separate question; answers are subject to subsequent publication if considered of exceptional interest.

Furnish sufficient information (in reference to magazine articles, be sure to mention issue, page, title, author and figure numbers), and draw a careful diagram (on separate paper) when needed to explain your meaning; use only one side of the paper. List each question. Be SURE to sign your name AND address.

Enclose only a STAMPED and self-addressed envelope for names and addresses of manufacturers; or, in connection with correspondence concerning corrections to articles, as this information is gratis.

Individual designs can be furnished at an additional service charge. The fee may be secured by addressing the inquiry to the SPECIAL SERVICE department, and furnishing COMPLETE specifications of desired information and available data.

"SLIDE-BACK" V.-T. VOLTMETER

(357) P. N. Normand, South Bend, Ill.

(Q.) I have heard reference made to a "slide-back" V.-T. voltmeter. Can you give me a simple circuit and description of such an instrument?

(A.) In Fig. Q.357 may be seen a circuit of a simple V.-T. voltmeter such as you request. The tube may be any type. (A 57 with the s.-g. and sup.-g. connected to the plate at the socket will give the highest sensitivity. A type 56 or a 27 are next in order.) The values for components M2, R2, and B2 depend upon the range to be covered. The operation is simple: the grid bias is adjusted by means of R2 to set M1 at a predetermined point; then the unknown voltage is applied to the input terminals and the arm of R2 is slid back until the M1 reading is at the original point; the difference between the readings of meter M2 for both positions of R2 is the value of the unknown voltage. (This holds only for D.C.) Other uses will suggest themselves to the reader.

(The above data printed by courtesy of *Sylvania News*.)

REGULATED POWER SUPPLY

(358) John A. Aerschi, Chicago, Ill.

(Q.) I have need for a power supply which will furnish unvarying high voltage. I have tried an ordinary radio power pack, but the voltage was not steady enough. What system of regulation can I use?

(A.) In Fig. Q.358A is reproduced a diagram of the RCA type TMV-118-B regulated power unit, which is designed to meet just the conditions mentioned. The unit consists of an ordinary radio power supply with supplementary circuits arranged to produce steady output, regardless of load (within its rating) or line voltage. The type 57 tube is the control tube which regulates the passage of current through the 2A3, V2. Tubes V4 and V5 further smooth the fluctuations which might occur in the output. The circuit is also arranged to have an extremely low hum level. The outward appearance may be seen in Fig. Q.358B.

CARRIER HUM MODULATION

(359) James Burley, Magnolia, Minn.

(Q.) Can you suggest a method of locating and curing a hum which appears on the carriers of all stations tuned-in on my midget A.C.-D.C. set?

(A.) The usual remedy for such a hum is the use of a bypass condenser of about 0.01- to 0.1-mf. from one side of the power line to ground, or where no ground is used with the set as is the case with most midgets, directly across the lines. It may be necessary to reverse the line plug to remove the hum. The condenser may also be tried from the plate of the rectifier tube to chassis.

CONVERTING A MILLIAMMETER TO A MICROAMMETER

(360) Sam Weinberg, Brooklyn, N.Y.

(Q.) I would appreciate information on the conversion of a 0-15 ma. meter to a microammeter. Can this be done without touching the coil?

(A.) The conversion you mention is practically an impossibility, and in any case the coil would have to be completely re-made. The *microammeter* needs a great many turns of very fine wire on the coil, while the *milliammeter* has comparatively few turns of rather coarse wire. Also, the magnet, hair springs and other parts would have to be changed. The construction of a "sensitive" meter (which is the only type capable of reading current values in *microamperes*) is a job for the most experienced craftsman.

It may be possible that your meter is a
(Continued on page 561)

FIELD-COIL DESIGN

(30) Carl H. Hibshman, Mufield, West Virginia.

(Q.) In a field coil for a speaker of the 6V. type, shall I use 600 T. No. 15 wire or 400 T. No. 14 wire?

(A.) The strength of the field coil is determined almost exclusively by the number of ampere turns. In other words, by the product of the number of turns and the current. Thus, with an average diameter of 6 ins., 600 turns of No. 15 wire will have a resistance of 1.6 ohms and will draw 3.75 A. at 6 V., making the number of ampere turns 3.75x600, which equals 2,250 ampere turns. The coil having 400 turns and the same average diameter will have a D.C. resistance of 1/2-ohm with a resulting current of 12 amperes at 6V. Therefore, its ampere turns will be 12x400 or 4,800 A. turns. In conclusion, the second coil will produce a pull about twice as great as the first one.

GENERATOR RIPPLE

(31) Lester E. Philip, Akron, Ohio.

(Q.) In using a carbon microphone with an amplifier that is operated by a 6 V. motor-generator, I notice that you can always hear the ripple of the generator in the loudspeakers. This becomes very objectionable when the volume control is turned up. What can I do to eliminate it?

(A.) The motor-generator noise you complain about is generally induced either by direct pick-up through the microphone transformer; by an unfiltered microphone current supply; or, by pick-up via the grid leads or tube elements within the tube itself. To prevent inductive pick-up by the transformer, the latter should be placed inside a high-permeability casting; and if the whole amplifier is very compact it might be necessary to use a hum-bucking type microphone transformer in a high permeability casting. Figure Q.31A shows the necessary filtering for the carbon microphone current supply when same is obtained from the storage battery (which also is utilized by the motor-generator). All the wiring of the first voltage amplifier tubes should be shielded and kept away from the filament circuit. We found from practical experience that the new, type 6C5 metal tube
(Continued on page 561)

Fig. Q.31, illustrating questions in the P.A. field.

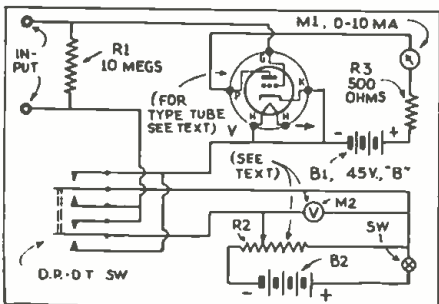
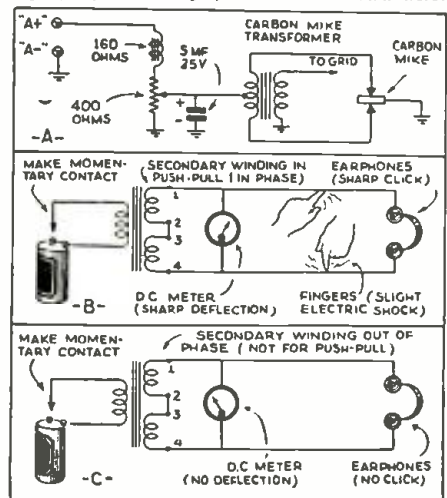

Fig. Q357, above. This simple vacuum-tube voltmeter will be found of great help to the experimenter. The D.P.D.T. unit is simply a reversing switch to change the polarity of B2. Resistor R3 is used simply to protect the meter, M1.

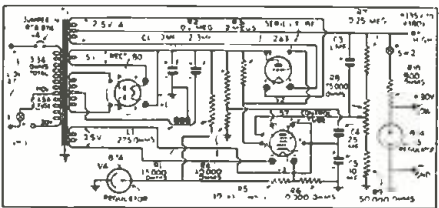

Fig. Q358A, diagram of the regulated power supply. Tube V5 is used only when the 90 V. tap is used.

Fig. Q358B, below, appearance of the power supply.



SOUND RECORDING ON MAGNETIC MATERIALS

This method of sound recording has found much favor in Europe—advantages and disadvantages are discussed.

WILHELM E. SCHRAGE

MANY EUROPEAN broadcast stations repeat in the evening hours a part of the most interesting daytime transmissions, as for example, "spot" reports on important happenings recorded during the day, or speeches of statesmen, etc. This method of sound storage, or as the broadcast technicians call it "play-back," is accomplished by various methods, the oldest of which is the wax recording process. But the wax record, although for years the only practical means for sound recording and play-back, does not entirely suit the needs of modern broadcasting because of limitations of its process.

The "lateral cut" method for example (see Fig. A), which is also used for the records for some home-type phonographs, can hardly be utilized to record and reproduce the audio frequencies above 4,000 cycles without great expense, especially if reproduction directly from the wax is desired, a situation which is often encountered in broadcasting. The reason for this is the fact that when the hard steel needle of the pick-up-head is led through the relatively soft wax-composition, the tiny wave cuts (which actually represent the recordings of the higher audio frequencies) are deformed or torn off.

HARDENING BY GOLD SPUTTERING

Since there is usually not sufficient time in broadcast-station operation to press the much harder and more durable shellac records from the original wax "master," another method has recently been used to harden the wax. It is the so-called "cathode sputtering process," by means of which a very thin layer of gold is sputtered onto the recordings on the wax disc. However, this method is not only very expensive but has disadvantages which have not as yet been eliminated.

TYPES OF RECORDINGS

A somewhat superior method to the lateral cut record is found in the vertical sound recording method, often referred to as "hill and dale" recordings (see Fig. 1B). This type of recording reproduces all frequencies up to 6,000 cycles when instantaneous play-back is desired. This method, mainly developed in this country, apparently has not been used in Europe—at least, not for direct play-back from the wax. The reason for neglecting this excellent method abroad was probably due to the tremendous strides which have been made during the past few years in Europe with the steel-wire ("telegraphone") recording method, which is

now about 35 years old. (It was invented by the Danish scientist, Professor Poulsen, in the year 1900.)

The method by which the steel recordings are made is shown in Fig. 1C. According to the current fluctuations, caused by a microphone, similar strong or weak impulses are magnetically recorded on the steel wire. How this method actually works, may be seen from Fig. 1D. In the upper part of this illustration we see the cross-section of a tremendously enlarged piece of steel wire. The small dashes signify the molecules of the iron, and, as we see, they are arranged in an orderly form if the wire bears no recordings.

WHAT HAPPENS IN THE STEEL WIRE

If such a piece of steel wire passes in front of the recording magnet (see Fig. 1C), the molecules will be disarranged because of the magnetic flux emanating from the recording magnet, which moves the tiny iron molecules to a moderately large degree. If such a piece of steel wire with "disarranged molecules" or magnetic recordings, is moved in front of the pick-up magnet, electromagnetic "disturbances" are produced in the pick-up magnet which are an exact replica of the original. Since it is easy to convert electromagnetic flux variations into electrical impulses by winding a coil around the pick-up magnet, the reproduction process is solved quite simply. The minute electrical impulses as furnished by the pick-up magnet-coil are sent at once through an amplifier connected to a loudspeaker, or if radiation to the broadcasting listener is desired, through an amplifier and thence to the transmitter.

Since a wire once recorded can be played-back as often as desired without wearing out, the recording time is theoretically unlimited. Through use of long wires the advantages of this recording method appears at first glance to surpass the qualities of any other.

RESTRICTED FREQUENCY RESPONSE

However, as is often the case, some important disadvantages are involved, as unbiased experiments by the Institute of Technology, Berlin (actually executed by the well-known Heinrich Hertz Institute) indicate. ("Magnetische Schallaufzeichnung auf Stahlbänder," Zeitschrift für technische Physik, 1932, page 593-599, and "Zur Theorie der magnetischen Tonaufzeichnung," Elektrische Nachrichten Technik, 1932, (Continued on page 562)

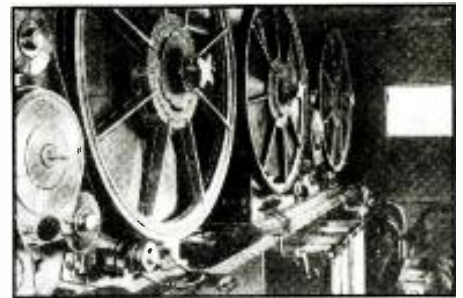
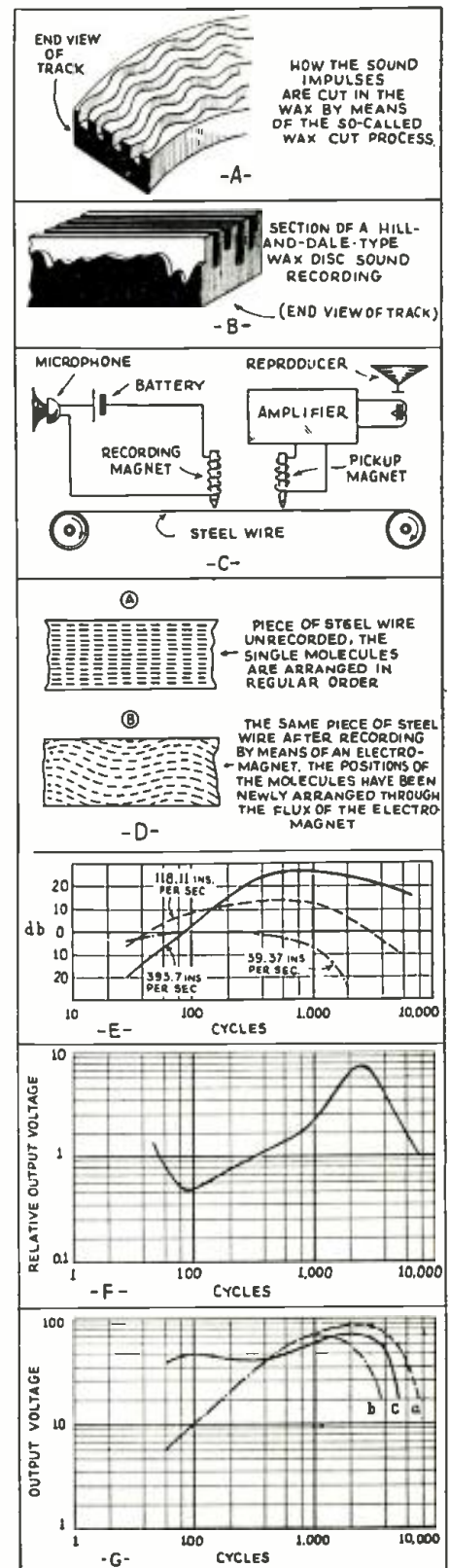

Fig. A, above. The interior of a German steel ribbon sound-recorder truck.

Fig. 1, below. Facts concerning magnetic recording on wire and ribbon.



SHORT-CUTS IN RADIO

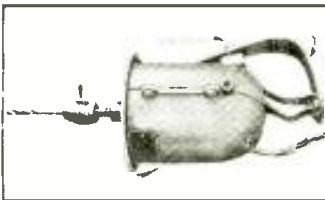

Fig. 1. Home-made electric drill.



Fig. 2. Selector switch.

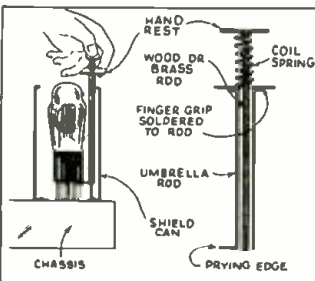

Fig. 3. A tube puller.

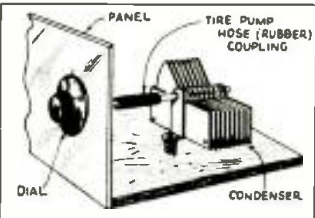

Fig. 4. Insulated flexible coupling.

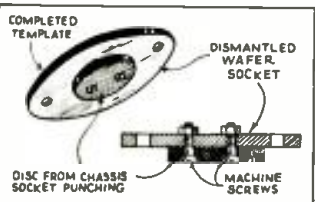

Fig. 5. Socket hole template.

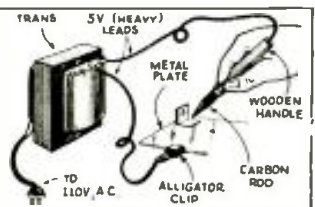

Fig. 6, above. Soldering "iron."

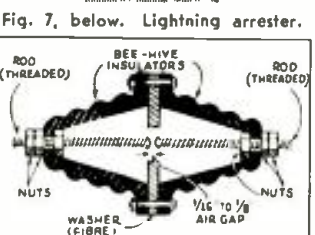

Fig. 7, below. Lightning arrester.

FIRST PRIZE—\$10.00

ELECTRIC DRILL. The drill shown in Fig. 1 can be made very economically and is very handy. The motor of this unit was taken from an old vacuum cleaner, while the chuck came from a 5 & 10 cents store drill. The handle is from a discarded metal pitcher. A steel ball bearing was imbedded in the end of the case to serve as a thrust bearing for the armature shaft. This drill has been found very good for all kinds of light work.

R. C. MIZENER

SECOND PRIZE—\$5.00

SELECTOR SWITCH. The switch (which I have found very satisfactory for use on test panels) shown in Fig. 2 may be made in any type from 4 to 8 contacts by use of the proper type of socket. The top lamination and the washer are removed from the socket, then the latter is replaced to hold the prongs in place. The shaft and bearing plate of an old volume control are then bolted onto the socket, using spacers between the two. The contact part of the prongs should be filed slightly in the center to provide a small groove for the arm contact to drop into.

THOS. A. CASERTA

THIRD PRIZE—\$5.00

TUBE PULLER. After loosening or pulling off several grid caps and spending many embarrassing moments, the tube puller shown in Fig. 3 was constructed and found to be highly satisfactory. In operation, the tube is wiggled slightly to allow the bent finger on the tubing to fit under the tube base. Then, a little pressure on the grips and the tube pops out of the socket.

HERBERT E. EHRET

HONORABLE MENTION

INSULATED COUPLING. A piece of tire pump hose inexpensively serves as a flexible coupling for remote operation of a tuning condenser. Refer to Fig. 4.

CHESTER STINE

HONORABLE MENTION

ACCURATE HOLE FORM. This template (see Fig. 5), made from one leaf of an old wafer socket and a metal slug, such as those formed when a socket hole is punched from a piece of metal, is used for spotting socket mounting holes in the most desirable position for securing the shortest leads.

FRANCIS HIGGINS

HONORABLE MENTION

COLD SOLDERING "IRON." The 5 V.-secondary of a power transformer from an old radio set is used to supply the energy for the "iron" (which, unlike the usual "copper," is made of "carbon") illustrated in Fig. 6. One heavy, flexible lead terminates in a heavy

FIRST PRIZE	\$10.00
SECOND PRIZE	5.00
THIRD PRIZE	5.00

Honorable Mention

EXPERIMENTERS: Three cash prizes will be awarded for time- and money-saving ideas. Honorable mention will be given for all other published items. Send in your best "kinks"!

alligator clip which is used as the ground connection. The other lead, which terminates in a holder, fastens to an electrode—a piece of carbon rod about 2 ins. long and 1/4-in. in diameter. (The type of rod used in arc lamps will do, or it may be taken from a flashlight cell.)

The clip is fastened to the material to be soldered and the rod placed on the part where soldering is to be done. When the part heats up, solder is applied. This iron is particularly handy, since there is no wait for heating up and it is always ready for use.

OSCAR O. BOUCHER

HONORABLE MENTION

LIGHTNING ARRESTER. An arrester is sometimes not at hand when an installation is being made. On one such occasion the arrester shown in Fig. 7 was made up and proved very satisfactory. It is made from 2 bee-hive-shaped stand-off insulators separated by a 1/4-in. sheet of bakelite and held together by bolts, as illustrated. The gap between the two brass-rod ends may be between 1/16- and 1/8-in.

JOS. G. TABACYZNSKI

HONORABLE MENTION

REPLACEMENT BRUSHES. The main problem is how to get a good connection between the carbon and the copper braid, where the Service Man finds it necessary (as in making repairs to farm equipment—motors, etc.) to make his own brushes from available carbon blocks. Figure 8 shows how this may be done. By mounting the brush at an angle in a vise both holes may be filled with solder at once. The pigtail may be of regular copper shielding on braid.

REX H. EYLER

HONORABLE MENTION

COIL WINDER. This year I have found a large number of coils defective, and in some cases replacements were impossible to get. As it was a long and tedious job to wind these by hand I rigged up the winder shown in Fig. 9. It is simply a portable phonograph, turned on its side so that the coil form can be fastened to the center of the turntable.

The nut is unscrewed from the turntable, the coil form slipped on, and the nut tightened in place. This frees both hands to guide the wire. Various shapes and sizes of coil forms will require different types of mounting but the user will have no trouble in rigging these up.

LEONARD H. CHILDS

HONORABLE MENTION

SOLDERING IRON CASE. In order to eliminate the usual wait for the soldering iron to cool off, when ready to leave a service job, the iron holder illustrated in Fig. 10 was built. It is constructed of No. 20 gauge sheet metal, lined throughout with 1/8-in. sheet asbestos. A slot is provided for the cord to pass through. The 2 pieces of metal used to hold the iron in place are riveted to the case. A single-wide rubber band is used to hold the 2 halves together. A case of the dimensions shown is large enough to hold a large industrial iron.

The ambitious Service Man may well build up a few of these boxes for sale to his friends. A little study will show how other equipment which is needed for soldering may be included in the same box. For example, a small spool of solder could be fastened at the handle end of the box which stays relatively cool.

R. T. SCHULTZ

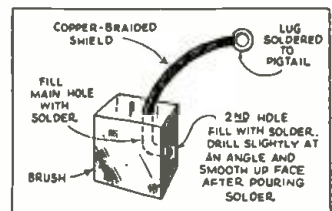

Fig. 8. Carbon brush replacement.

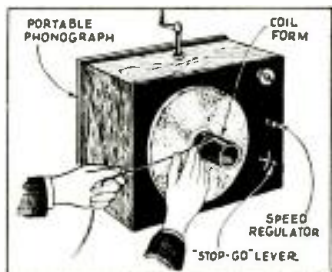
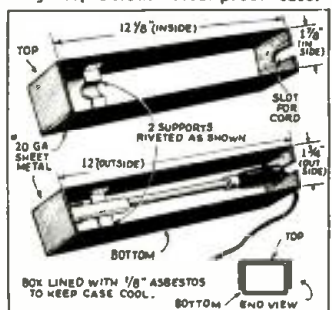

Fig. 9, above. Coil winder.

Fig. 10, below. Heat-proof case.



DIRECTED SOUND— A NEW METHOD OF "INDIVIDUAL" RECEPTION

In this exclusive article to RADIO-CRAFT, Mr. Cahill describes something new in radio and hard-of-hearing devices.

ARTHUR T. CAHILL

IN ALMOST every home, radio is a privilege, a source of amusement, enjoyment and instruction, including music and latest news of the day; and also more or less of a nuisance and constant source of friction, owing to the diversity of tastes and occupations of different individuals of the same family or occupants of the same house. One person wishes to work or study—to concentrate—and someone else wants the radio set turned on full power, and the two desires do not mix.

To correct this condition a new invention in radio, and also in aids for the hard-of-hearing, which permits individualized sound reception was made by the late Dr. Thaddeus Cahill, inventor of the Telharmonium (an instrument for generating music electrically at a central station and distributing these electrical vibrations either over wires or by radio to subscribers all over the country).

Dr. Cahill's idea was to make a *silent radio easy chair*, in which a person could sit at his ease and listen to radio programs under the most favorable circumstances, having all the volume he wanted, and yet without disturbing others in the same room. This is done by suspending two speakers, one on either side of the listener's head, near his ears.

Several applications of "the silent radio chair," as the complete patented set-up is called, are listed in Table I. Service men have here a new source of income.

Table I

(1) Personalized reception of radio programs at loudspeaker volume and quality—insofar as the individual listener is concerned, with or without the operation of a reproducer for group reception.

(2) Aid for the hard-of-hearing in home and industry.

Fig. 1. Construction of Cahill reproducers.

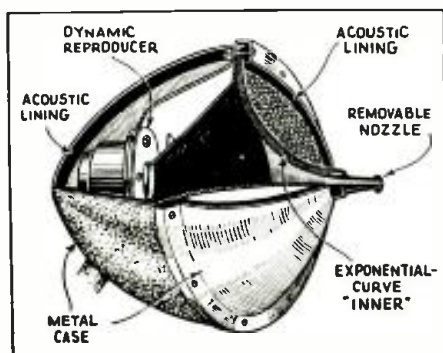

(3) Aid for dictation in large office and noisy locations.

(4) Quiet telephone conversations.

(5) Hospital radio reception by mounting the reproducers in hospital beds.

THE GENERAL DESIGN

Most of the principles involved in the Cahill silent radio chair will be easily understood from the accompanying illustrations and description. Two high-grade dynamic reproducers, generally of 8 in. size, are suitably arranged in a special universal mounting and placed near the ears of the listener. Owing to the mechanism in Fig. C, which will be readily understood, the housed reproducers may be moved (a) up and down, (b) in and out, (c) towards and away from the ears of the listener, and (d) towards and away from the back of the chair, by a touch. In this way the assembly may be moved in any direction to suit the height of the person using it, and to suit his position, whether leaning back against the back of the chair, sitting bolt upright, or leaning forward, or to one side of the chair or the other, as the case may be.

The weight of the speakers, speaker-cases, pipe frame and supporting pipes, is quite considerable, and, of course, has to be counterbalanced in every direction. Three counterbalancing systems are used. The first, or main counterbalancing system counterbalances the speakers against gravity as they move up and down, towards and away from the floor. The second counterbalancing system counterbalances the encased reproducers as they are adjusted towards or away from the back of the chair. The third counterbalancing system counterbalances the reproducers as they move in and out towards or away from the ears of the listener.

If the speakers were merely suspend-

Fig. C, right. The 3-way counterbalance used for the heavy reproducer structure. Fig. 2, below. One switching method used.

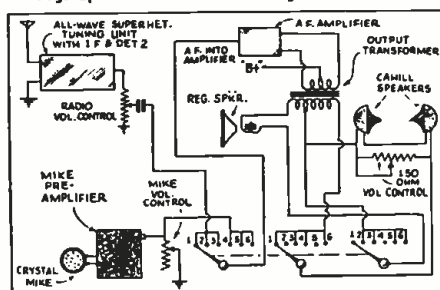

Fig. A. "Silent" radio reception is possible.

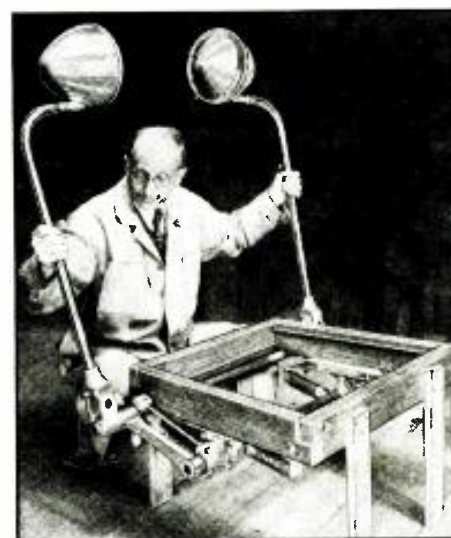

Fig. B. The system can be used by the hard-of-hearing for "2-way talking" to persons in the room or other parts of the house or office. One novel arrangement is illustrated: In Fig. A, a person listening to a radio program is seen talking to other people in the room, who do not hear the "ear loudspeakers" in operation. The speaker's voice is being picked up by a microphone; the speaker is varying the degree of microphone amplification. In Fig. B, a person who ordinarily would be "out" of the conversation, due to impaired hearing, is seen varying the degree of amplifier output of the voices picked up by the microphone (Fig. A).

ed, close to the listener's ears, one on each side of his head, as was at first intended, the sound in the room would be very greatly reduced, but it would not be completely eliminated. When the music was soft, it would be completely eliminated, but if the listener in the chair desired to have a loud sound in his ears, such as a good orchestral climax, it would be more or less audible throughout the room, owing to the well known capacity of the ear to pick up the faintest of sounds and, at the same time, to tolerate the loudest of sounds.

DESIGN OF THE "EAR REPRODUCERS"

To overcome this situation the speakers are placed in *acoustic cases* which, as will be seen by reference to Fig. 1, externally are of an elliptical design, (Continued on page 564)



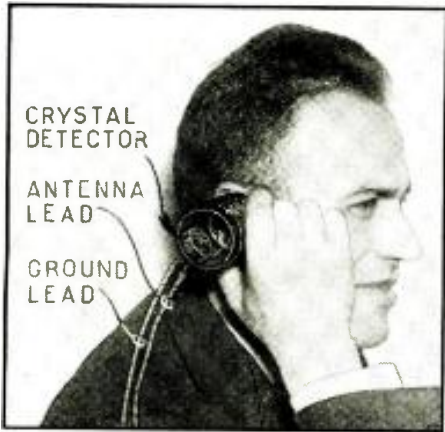

The pocket receiver in use. Tuning for loudest signal strength is accomplished by moving the fingers over the coil surface.

A POCKET-SIZE BEGINNER'S CRYSTAL SET

This "local-station" receiver will fill the need for an elementary set for the beginner to start on.

STANLEY JOHNSON

THE LITTLE set illustrated is so small that it can be slipped into a coat pocket, yet when fastened to a makeshift antenna it will bring in the local broadcast station with surprising clearness. All of the parts, including the earphone and the fixed crystal detector, are contained in a small bakelite tube.

In building the set, one phone from a good pair of bakelite-case headphones is glued in the end of a piece of bakelite tubing, 2 ins. in diameter. On the tubing is wound the coil, which consists of 70 turns of No. 22 D.C.C. wire. (The number of turns may be varied as necessary to tune the set to the most powerful station received in a given locality.) The crystal de-

tector is fastened with machine screws to the inside of the bakelite tubing, near the end. When the set is being carried, the antenna clip and 6-ft. pick-up wire are pushed inside.

To use the set, the clip is fastened to an antenna and the set is held to the ear with one hand. Holding the set in the hand not only utilizes the capacity of the body to aid in picking up the station, but also makes it possible to tune for maximum volume sim-

ply by changing the position of the fingers on the coil. The position is not critical.

Of a number of things used for antennas, the best signals are received with the clip fastened to a bare metal part on a telephone. Other satisfactory make-shift antennas include wire trellises, metal clotheslines, metal drain-pipes, and electric-light fixtures. Of course, a regular receiving antenna may be used with excellent results.

The extremely simple wiring of the coil, fixed crystal detector and phone unit can be seen here. The antenna clip is a battery clip which facilitates connections to an "aerial." (Connect a .002-mf. condenser—not shown—to the two terminals of the earphone.)

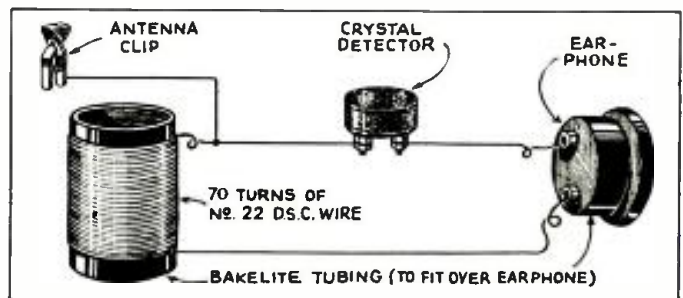

2-DOZEN IDEAS FOR YOUR SERVICE SHOP

ALFRED A. GHIRARDI

Some ideas brought to light in the "Ideal Service Shop Contest" are tabulated for Service Men and other readers.

CONTESTS, such as the "Ideal Radio Service Shop" contest sponsored by *Radio-Craft* recently, always bring to light a great many interesting ideas which the participants never fail to incorporate in their letters. The hundreds of letters which the judges of this particular contest were called upon to read revealed an unusually large crop of these clever shop hints or "kinks" which the men had mentioned along with their description of their ideal service shops. Some of these ideas were so interesting that it was thought worthwhile to record them

here for the benefit of the large number of Service Men readers of *Radio-Craft* who are always on the alert for new ways to improve their shops and their service. The "kinks" listed here may not be original, or they may not even be new to many readers—no such claims are made for them. They are presented here mainly for completeness, and for their general interest. Here they are:

1) Build and equip a small combination "test" and "work" bench especially for auto-radio work, and mount it on castors so that it may be brought

right up to the car. A discarded "tea wagon" serves nicely for this purpose. It may also be wheeled to any part of the shop to serve as an "auxiliary" or "emergency" test panel.

2) Have your test panel hinged at the bottom so that if anything goes wrong, it can be swung forward and the connections checked or the repairs made. (Fig. 1D.) It is good policy to have all panels enclosed at the rear for protection against dust.

3) The complete test panel rack can be mounted on four rollers, free to run on a pair of rails embedded in the entire length of the bench top. In this way one set of test units can serve two men working on a test bench. (Fig. 1D.)

4) Have small compartments or drawers below the test panel for keeping replacement resistors, condensers, etc., within convenient reach while working on sets. (Fig. 1D.)

5) Have a "substitution" panel, which consists of various common replacement components, with their terminals brought out to tip-jacks, so that any of these can quickly be hooked into its respective place in a receiver circuit. These (Continued on page 566)

A few of the hints are presented pictorially in the sketches below.

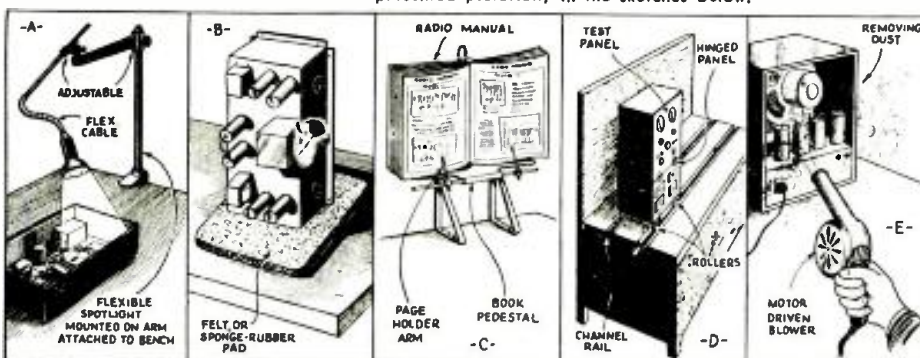

RADIO-CRAFT receives hundreds of magazines from all parts of the world. Since the cost of subscribing to each of these would be prohibitive for most radio men, we have arranged with technical translators to prepare reviews for our readers.

INTERNATIONAL RADIO REVIEW



Fig. A. The appearance of the crystal set.

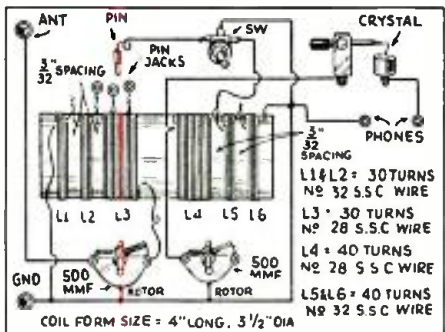

Fig. 1. The wiring diagram of the set.



Fig. B. This case is decorative yet useful.

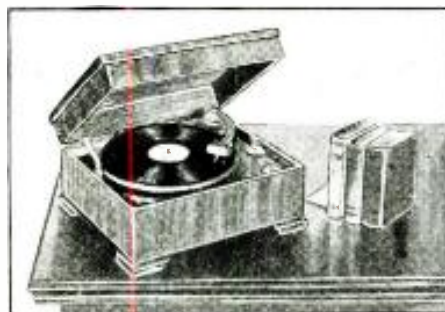
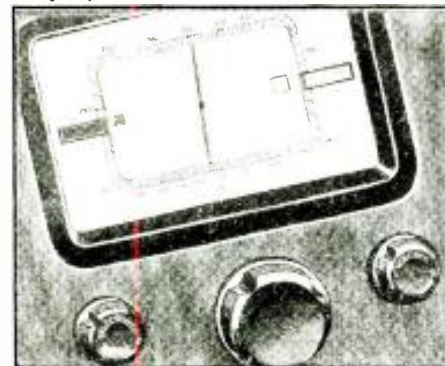

Fig. C, above. A phonograph unit.

Fig. D, below. The "fototune" receiver dial.



A BEGINNER'S CRYSTAL SET

THE RADIO beginner will find interest in the selective crystal receiver shown here, which appeared in a recent issue of *Popular Wireless* (London).

This set, unlike the crystal sets of years ago, in most localities, is selective enough to separate the local stations. The set shown in Fig. A, is designed to cover the regular broadcast band from 200 to 550 meters, and because there are several broadcast stations in Europe which operate on long wavelengths, the coils also are designed to cover wavelengths up to about 1,500 meters. The American builder can omit these long-wave sections from the coil if desired, but there are some interesting weather reports, airplane navigation and flying instructions and time signals on the air.

The values of the parts and the picture wiring diagram (Fig. 1) tell all that is needed to build this simple set. (Connect a .002-mf. fixed condenser—not shown—to the two phone posts.)

A VIENNESE METAL-CASE SET

A RECEIVER of unusual appearance was shown in a recent issue of *Radio Welt* (Vienna). The set, shown in Fig. B, was designed from two angles—(1) appearance, and (2) utility; for the cabinet, made of dull-finish metal and molded bakelite, is both attractive and scientific. The louvers which are pressed in 4 rows over the top of the cabinet supply the ventilation so much needed in modern sets—and they also act as an attractive finishing touch to the modernistic appearance of the set. The receiver, itself, covers the wavelengths from 18 to 2,000 meters in skip bands—the output is 10 W.

A PHONO. ATTACHMENT

THE RETURNING popularity of phonograph music in Europe, and especially in Australia has brought forth a new crop of phonograph units which may be attached to radio sets in order to utilize the A.F. amplifiers and speakers of the sets.

One such unit, Fig. C, which was announced recently in *Radio and Electrical Merchant* (Sydney, N.S.W.) is housed in an attractive wooden box and is equipped with either a 2-speed or single-speed motor of high-quality design. This unit has a crystal pickup on a curved tone-arm, according to latest European style, which is equipped with an automatic stop to turn it off at the end of the record. The attractive table-type cabinet can be placed on any convenient piece of furniture up to a distance of 20 ft. from the radio receiver. The quality, of course, depends on the

(Continued on page 563)

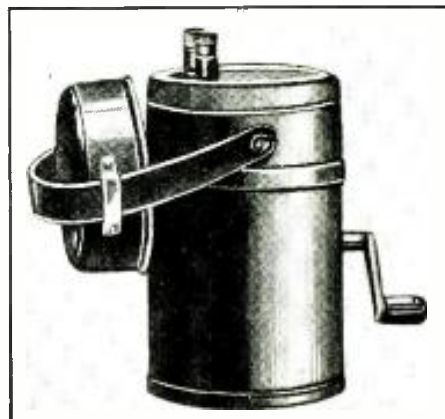

Fig. E. A hand-operated ohmmeter generator.

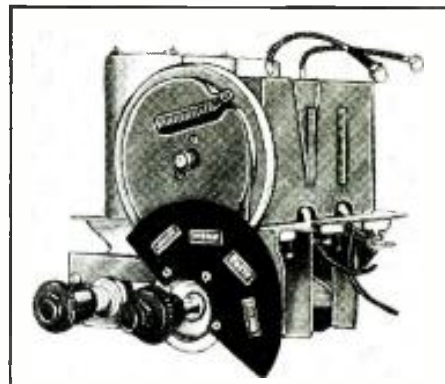

Fig. F. The tuner unit of the set below.

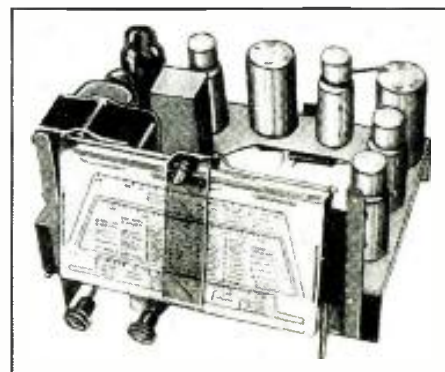
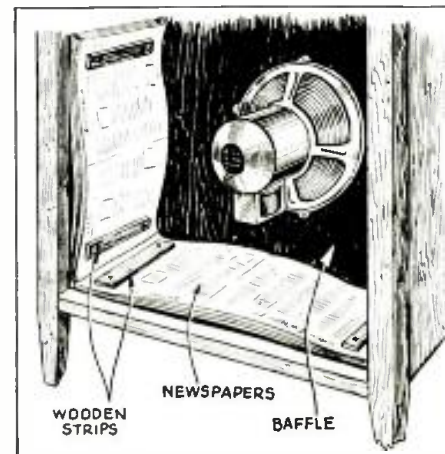

Fig. G. The tuner fits into this chassis.

Fig. 2. The air pockets reduce resonance.



THE LATEST RADIO EQUIPMENT



Knock-down workbench. (923)



A transceiver handset. (924)

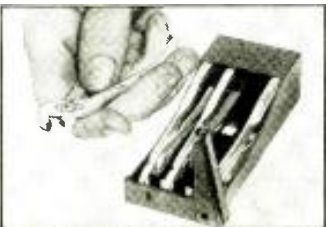

A small-plier kit. (925)



Above, newest doublet antenna. (926)

Below, a 14-W. P. A. system. (927)

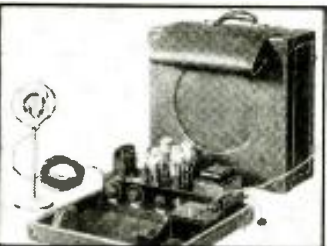

Below, left-center, a multirange meter. (928) Center, a metal-tube-like ballast resistor. (929) Right-center, newest iron-core I. F. transformer. (930)

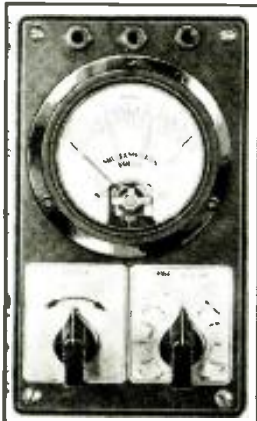

OCTAL BASE

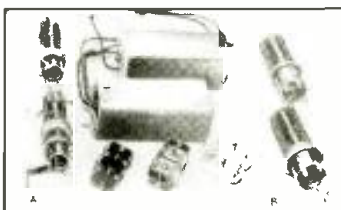

Dual-range super. kit. (931)

WORKBENCH (923)

STRONGLY made of green-enam-
ealed steel and varnished hard-
wood, with steel drawer, this bench
will be a useful addition to any
shop. Furnished with 21 tools, as
shown. Comes in knock-down form.

"5-METER" HANDSET (924)

(Universal Microphone Co.)

ALTHOUGH designed expressly
for use with 5-meter trans-
ceiver equipment, this new bakelite-
case handset can be used for inter-
communication systems (where it is
not desirable to use amplifiers).
This latter use is made possible by
the high output of the microphone
(available in single- or double-but-
ton) and high sensitivity of the re-
ceiver (available in several im-
pedances). Its 4 leads afford many
circuit combinations.

PLIER SET (925)

A SET of 4 different types of 4½-
in., silver-finish, rust-proof
pliers is available to the constructor.
The types are: standard, parrot-
needle-, and flat-nose. Made of cor-
rectly-tempered, special alloy steel.
Furnished in handy, pressed-metal
carrying box.

DOUBLET ANTENNA KIT (926)

COMPLETE material, including a
special, variable (for best re-
sults on the various bands) coupler
for use at the set end of the lead-
in, and a doublet-type lightning ar-
restor, is available in kit form for



A service chest. (932)

the erection of an all-wave doublet
of the latest design.

An "assembled" kit (illustrated)
is available for the beginner who is
uncertain as to how the two 33-ft.
horizontal wires, the 75-ft. down-
lead, the 25-ft., and the insulators,
"hook up." Sets designed for a
doublet probably will not require
the coupler.

HIGH-FIDELITY 14 W. PORTABLE P.A. SYSTEM (927)

RESISTANCE-coupled class A
push-pull amplification is used
in this portable amplifier. Input:
double-button microphone and high-
impedance phono, pickup (individu-
al controls afford fading facilities).
Output, 14 W., into 12 in. dynamic
reproducer; overall gain, 70 db. Net
weight, 40 lbs. Utilizes 1-56, 1-53,
2-2B6s and 1-5Z3.

PORTABLE TEST UNIT (928)

THE "MOLDARTA" case of this
compact test instrument measures
only 7 x 4 x 3¼ ins. deep. The ac-
curacy of this new unit is within
2% on D.C. and 5% on A.C. Three
ohm scales, 1,000, 0.1-meg., and 10
megs., are provided. Voltage scales:
1.5, 15, 150, and 750, D.C. (1,000-
ohms-per-volt); and 15 and 150,
A.C. Current scales: 15 and 150 ma.

VOLTAGE-DROPPING RESISTOR (929)

MANY different ratings are
available (including those in-
tended to be used with pilot lamps)
in this new "A.C.-D.C.", above-
chassis-mounting resistor, which
looks so much like the old metal-
tube (5Z4) rectifier. Base is octal
(8-prong). Approved by the Under-
writers.

HIGH-GAIN "IRON"-CORE I. F. COILS

TWICE the selectivity and gain
of the ordinary air-core type
transformers is said to be obtained
with these new units that utilize a
"crowlite" core. Trimmers are mica,
compression-type. Cans measure
1½ x 1½ x 3½ ins. high. One I.F.
stage using these units is said to
equal the gain and selectivity of a 2-
stage amplifier using air-core trans-
formers.

The core material, as described in
a recent issue of *Radio-Craft*, is a
rustless and corrosionless alloy of
finely-divided magnesium, embedded
in a ceramic body. Available in all
standard frequencies.



Socket-hole punch kit. (933)

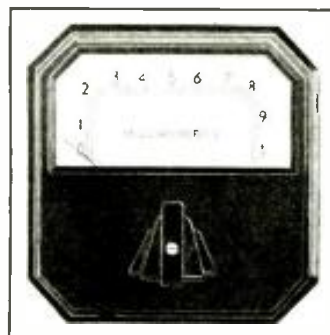

Modernistic meter. (934)



Tiny "mike" transformer. (935)



New octal socket. (936)

ALL-WAVE COIL SETS (931)

SUPERHET. KIT—
A SET of coils for use in a 2-band
superhet. is shown at A.
Ranges: 536 to 1,700 kc., and 5,700
to 17,000 kc.; the I.F. intermediate
is 456 kc.

R.F. KIT—
At B is a set of coils for a 2-band
T.R.F. set. Range: 540 to 4,500
kc. The coils in these kits are of
high-gain type; sets built with these
coils are very sensitive.

TECHNICIANS' SHOP CHEST (932)

(Solar Mfg. Co.)

A DURABLE steel chest provided
with a carrying handle, lock-
doors, and numerous compartments
and drawers, is now available for
(Continued on page 567)

Name and address of any manufacturer will be sent on receipt of a self-addressed, stamped envelope. Kindly give (number) in above description of device.

PUBLIC ADDRESS SYSTEM (939)

LOW COST and high fidelity performance are said to be the features of this complete P.A. system. A condenser microphone with floor stand, and 2 tone-equalized dynamic reproducers in special acoustical baffle cabinets, and all cables are standard equipment. The amplifier is of the high-fidelity type and the equipment is entirely A.C. operated. Utilizes 2-6A6s, 2-42s, and 1-82. Balanced push-pull amplification in all stages and resistance coupling throughout reduce hum and distortion. A special low-impedance input is provided for operation of other apparatus.

HIGH-FIDELITY DIAPHRAGM-TYPE CRYSTAL MIKE (939)

A NEW principle is used in this studio-type crystal microphone. It is so designed that the forces of 2 opposed diaphragms are applied to one crystal. The advantages of this type of construction over that of the older type crystal construction may be likened to the advantages of a push-pull amplifier over a single-ended amplifier. The construction is such that increased forces are applied to the crystal, and at the same time sufficient damping is automatically applied. The output is considerably greater than that of units which use only 1 diaphragm or those in which the sound waves actuate the crystal directly. The frequency response is substantially flat from 20 to 5,000 cycles per second, with a gradual rise to 10,000 cycles per second. Compensation is made for changes in barometric pressure. Output is conservatively set at -64 db. The microphone is non-directional and may be operated quite close to the reproducers without troublesome feedback. There is absolutely no background noise. The pickup area is exceptionally good but where necessary it is possible to speak close to the microphone without overloading it, a feature which recommends it for use by orchestras which have vocal reinforcement.

The interior construction is shown in Fig. 939B, and here the 2 opposed diaphragms may be plainly seen. The single graphofoil crystal is seen in the center, while the yokes which terminate at opposite corners fasten directly to the diaphragms. It may be seen that the crystal has no other support than the actuating yokes. The 2 diaphragms are fastened to opposite sides of the support ring which, in turn, is attached to the microphone case.

MULTIMETER KIT (940)

(Allied Radio Corp.)

SIMPLICITY is emphasized in this test unit, although it will measure 0-10-25-50-100-250- and 500 V. D.C. and resistances of 0-1,000 ohms and 0-1 meg. A zero setting control, R1 in Fig. 940B, is provided for accuracy of resistance readings. The resistors used are of the semi-precision type which give good overall accuracy, and the selector switch is very smooth in operation to provide for ease of use.

The meter used is of the latest fan type and has a knife-edge pointer and extra-long scales. The movement has laterally-wound coils and fatigueless springs which assure perfect operation at all times.

The parts are furnished in kit form.

Condensers may be tested for shorts or open conditions, transformers may be checked and many other tests quickly and accurately made.

THE NEW "BIAS CELL" (941)

FOR some time there has been felt a definite need for an economical system to furnish grid bias to high-mutriodes, the 75 and 2A6, other than the method of self-bias. Figure 941A represents the circuit often used, where bias is obtained from the drop through resistor R. Condenser C is a high-capacity electrolytic needed to prevent degeneration. This circuit is susceptible to overload which causes distortion. Such trouble is overcome to a certain extent in Fig. 941B, but here we have a certain complication of circuit and besides there is still trouble from early overload. The problem has been satisfactorily solved through the use of a new "bias cell" (see Fig. 941C). Here we have a definite bias of about 1 V. on the grid, regardless of circuit conditions. Degeneration is avoided and there is not such likelihood of overload and distortion. Note also the simplicity of the circuit in comparison with that of Fig. 941B.

A view of several of the bias cells is shown in Fig. 941E, together with a holder designed for such use.

The general principle of interior construction is illustrated in Fig. 941D, although the actual construction is slightly different. The component elements are approximately as follows:

- 1—casing of insulating material
- 2—aluminum cathode disc
- 3—sealing washer of rubber
- 4—cotton plug impregnated with ethylene glycol and boric acid
- 5—vanadium pentoxide anode
- 6—washers of lead
- 7—metal end cups
- 8—spring to hold elements together.

The cell is a potential producing device *exclusively* and if a current of as little as $\frac{1}{2}$ microampere is drawn from it the voltage rapidly drops to a very low value. After such a load the voltage will slowly return to the normal 1 V. value. When no current is drawn, the life of the cell is practically indefinite, as is its life under normal use!

SCHOOL SOUND SYSTEM (942)

HERE IS a complete and flexible educational system for use in the school which may be expanded to meet any need. The main control cabinet is shown in Fig. 942C. This contains all apparatus including a radio receiver, and an automatic record changer. The system is adaptable to either 1 or 2 channel use in any required output power. The output stages are supplied in units of 20 W. so that the only equipment needed to enlarge is the output amplifier unit and additional key strips for the main cabinet.

The power type of speaker to be used in auditoriums is illustrated in Fig. 942A. This unit has a built-in power supply and an amplifier of 10 W. capacity. The actual consumption is only about 0.6-W. which permits any number of these large speakers to be added without the usual expenditures needed on the main amplifier. Various types of mountings are made for this speaker.

The small type of reproducer used in rooms is illustrated in Fig. 942B.

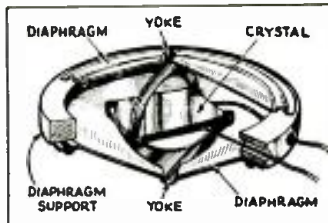
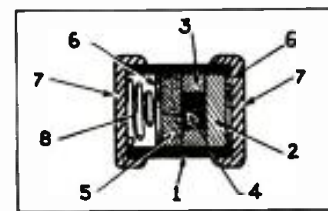
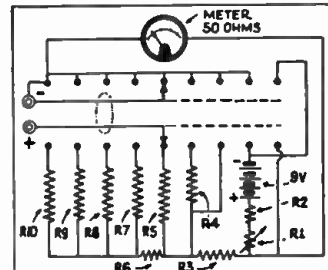
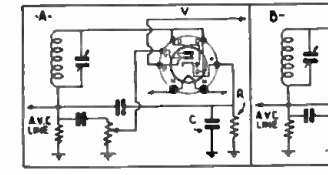

Fig. 940A, above. A handy meter for the experimenter. Below, Fig. 940B, the circuit. Note the simplicity.



Above, Fig. 941D; right-above, Fig. 941E; below, Fig. 941. New bias cell and use.



Above, left, Fig. 939B; directly above, Fig. 939A. Diaphragm-type crystal mike.

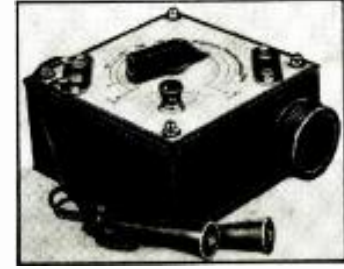
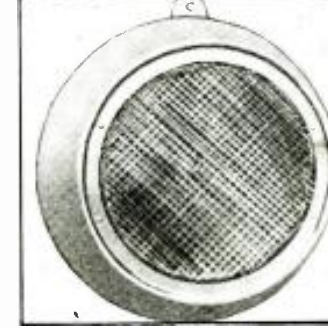

Fig. 943. A compact condenser tester.



Above, Fig. 941D; right-above, Fig. 941E; below, Fig. 941. New bias cell and use.



Left, Fig. 942A; left-below, Fig. 942B; below, Fig. 942C. School sound system, and its different types of reproducers.

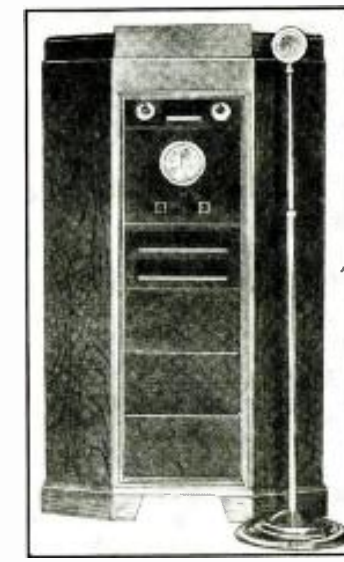



A FINE CANADIAN SHOP

RADIO-CRAFT, ORSMA Dept.:

As an ORSMA member, I believe some of the other members may be interested in a picture of my workshop at home.

All the instruments are set into the panel but may be removed at will. On the left is an A.C.-operated oscillator. Next comes a Supreme analyzer followed by a condenser tester, (data on which I obtained from the Members' Forum of the July, 1935 issue). The instrument lying flat on the table is a Supreme tube checker. A full set of service manuals is on the shelf.

Hope this description will be of interest to other members.

JOHN MISHKIN,
Montreal, Canada.

HOW TO MAKE A SIMPLE WATTMETER

RADIO-CRAFT, ORSMA Dept.:

Here is a simple method of constructing a wattmeter, which is as accurate as needed for ordinary measurements. The device may be calibrated by the use of bulbs, electric irons, or any other apparatus of known (note the emphasis) drain.

There is only one precaution to observe—have the meter shunt fastened in place firmly so that it cannot be removed unintentionally, as removal while the apparatus is in operation will ruin the meter. Incidentally, various ranges may be had by using different sizes of shunts for the meter, but the switch used to change the range must be of the shorting type.

The line voltage across A-B should always be adjusted to read 100 V. before taking a measurement of watts drain.

Initial calibration should be made with a 50-W. lamp. Then other appliances may be connected to the output socket, and meter readings noted until enough are obtained to make a calibration chart.

I believe Service Men will find this apparatus of some use.

EUGENE KINGREY,
Dayton, Ohio.

Most radio sets are now rated by the makers as to watts power, so this handy means of finding the drain should appeal to Service Men.

The radio service shop of Arthur Chaisson.

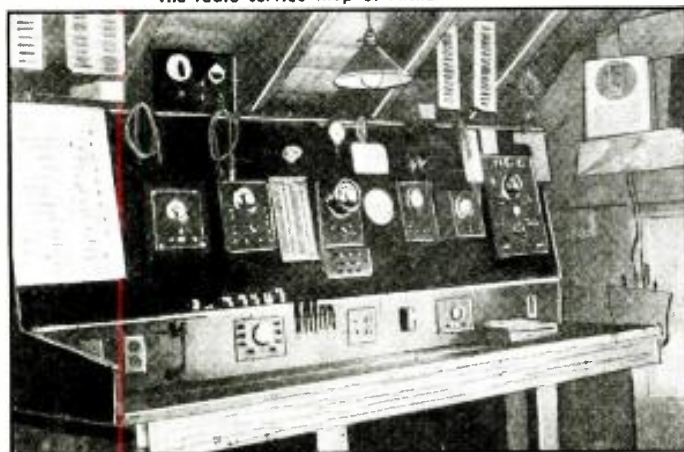

A NEAT SHOP

RADIO-CRAFT, ORSMA Dept.:

I am sending you a picture of the service bench that I am using at the present time and hope that it may be of interest to some of you *Radio-Craft* readers.

ARTHUR CHAISSON,
Mezico, Maine.

We are always glad to print good clear pictures of service shops, since in many cases, readers may be able to get valuable tips from them which will help in the arrangement of their own shops.

ASSOCIATION EXCHANGE—A SUGGESTION

RADIO-CRAFT, ORSMA Dept.:

Enclosed is material pertinent to the happenings of the Philadelphia Radio Service Men's Association.

I believe great work could be accomplished if the Publicity Men of the different Radio Service Associations throughout the country would swap information concerning the ramifications of their successful publicity ventures.

I know that *Radio-Craft* is interested in promoting the welfare of such organizations. Therefore, would it not be a good idea for your magazine to run material pertaining to association doings of a constructive nature? It would be appreciated by your readers. I am sure.

Thank you for your cooperation.

PAUL G. FREED,
Chairman, Publicity Committee,
Phila. Radio Service Men's Assoc.,
Philadelphia, Pa.

Mr. Freed sent us a report of his Association's activities at the recent Philadelphia Radio and Electrical Show. Unfortunately we haven't the room to print this data but would appreciate hearing from other associations on Mr. Freed's idea of exchange.

NOISY RECEPTION—BUT READ ON!

RADIO-CRAFT, ORSMA Dept.:

Being a member of the ORSMA and a subscriber to *Radio-Craft*,

I am sending some "dope" on a very unusual service job I had recently.

ECHOPHONE D.C. MIDGET. The set was an Echophone D.C. midget and I had to work on it in the customer's home (since my shop is located in an A.C. district). I turned the set on, and there was noise all over the dial. When I removed the antenna the noise still came in, but at greatly decreased volume. I supposed the noise came in from outside, but to make sure I grounded



Above, the service shop of Mr. Mishkin in Montreal. Below, an easy method of determining watts drain.

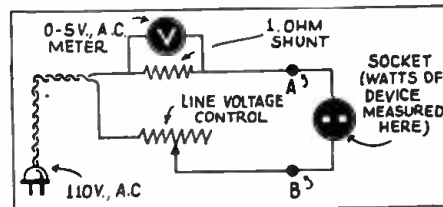

the detector grid, and to my amazement could still hear the noise—although still weaker.

A thorough testing of the set revealed no trouble, but as I was finishing this I noticed that whenever the noise was on, the filaments flickered slightly. I accidentally moved the D.C. line cord and the noise stopped. One side of the cord was found to be making intermittent contact, the rubber holding the ends together. The break was caused by a rocking chair over the wire, the wire being run under the carpet.

The noise apparently entered the set through the antenna but the intermittent break of the wire caused an audio disturbance which accounts for the fact that the noise came in when the detector was grounded.

JOSEPH BALSAMELLO

ODD SET TROUBLE

RADIO-CRAFT, ORSMA Dept.:

I had an odd experience with a Zenith No. 2012 set that might occur with most any make so am passing it on.

This set was brought into the shop with the complaint that it would cut off after playing ½ to 1 minute after it had been switched on. All tubes were checked and found "satisfactory," after which all parts of the set as well as voltages were likewise checked and found to be perfect. The tubes were then tested in 3 dif-

(Continued on page 568)

FAIRBANKS-MORSE MODEL 81 2-BAND 8-TUBE 2 V. "FARM" SET (Ranges—540 to 1,740 kc., 5.5 to 16 mc.; full A.V.C.; class B output; R.F. stage; new type speaker.)

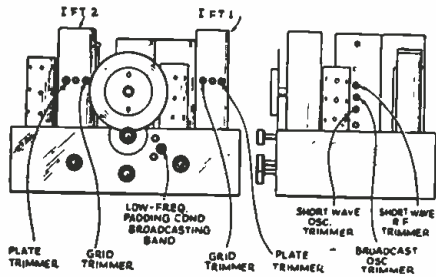

This set has provision for use on either dry cells, storage cell, or air cell. An Amperite 6-1 ballast tube is needed for 3 V. operation. For air-cell use, a resistance link is inserted in the socket provided for it in the set. A jumper link is plugged into the same socket when a storage cell is employed.

When a doublet antenna is used on this set one lead connects to the blue wire, and the other to the blue and black wire.
I.F. alignment is made with the band switch in the broadcast or left-hand position. Supply a 465 kc. signal to the cap of the 1C6 tube and adjust trimmers on first I.F. transformer and then on the second.
R.F. alignment on the broadcast band is made first on 1,400 kc. with the signal fed in through the antenna post. The oscillator trimmer is adjusted first, then the antenna trimmer. Then a 600 kc. signal is used and the oscillator padding condenser adjusted.

Tube Type	Plate Volts	S.-G. Volts	C.-G. Volts	Fil. Volts
V1	165	65	2
V2*	165	65	2
V3	165	65	2
V4	2
V5	65	35	2
V6	145	2
V7	165	12.5	2
V8	165	12.5	2

*Anode grid-165 V. All voltages measured from ground with 1,000 ohms-per-volt meter, 300 V. scale.

After re-aligning, it will often be necessary to reset the dial. This is done with the chassis bolted in place. The set-screw in the travelite dial hub is loosened and the dial turned to the correct location.

The speaker may be adjusted by means of the 3 screws on the rear.

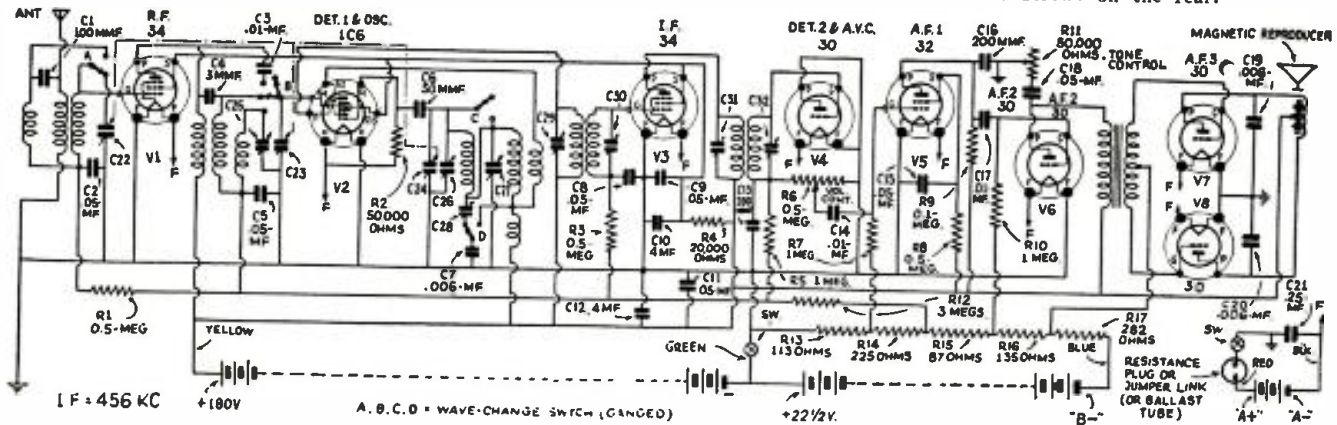

FIRESTONE-STEWART-WARNER MODEL R-1332 5-TUBE AUTO RADIO (Power supply protective resistor; calibrated dial; tone control.)

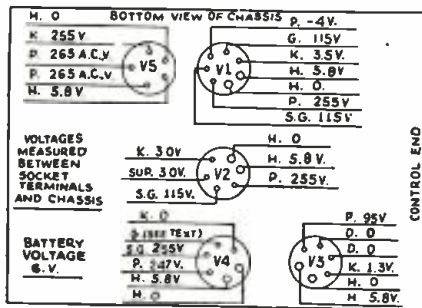

The chart at the left shows the locations of the tubes and their voltages, as measured to chassis. The usual high-resistance meter must be used. The bias on V4, of -23 V., is measured from chassis to the ungrounded filter choke terminal.

With the volume control set at maximum, attach the service oscillator between V1 grid cap and chassis, and adjust all I.F. trimmers for best signal. R.F. alignment is made at 1,400 kc., the adjustment being made on the trimmer located nearest the shaft end of the gang condenser.

The dial calibration may be corrected by tuning to a station of known frequency around the center of the dial and, while holding the knob so that it cannot turn, set the pointer to the correct position. The screw that controls the pointer is at the rear of the control head, and may be turned by an ordinary small screwdriver.

The special "global" protective resistor across the secondary of the power transformer cannot be tested with an ordinary ohmmeter since it will have a resistance of several megohms when cold.

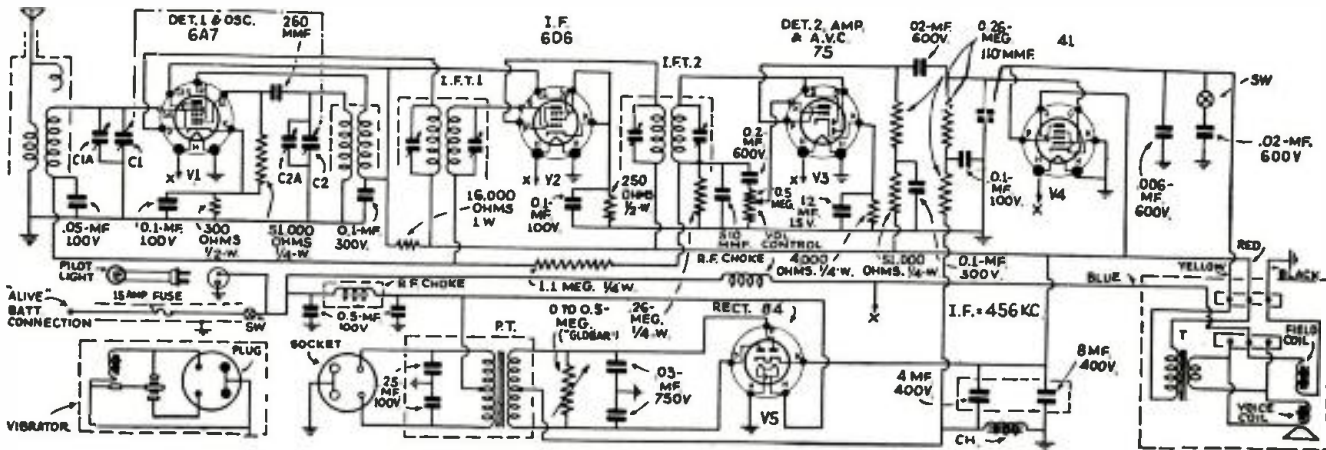

INTERNATIONAL RADIO CORP. MODEL 90 4-TUBE SET AND POWER SUPPLY

(110 V. A.C.; and 6 V. or 32 V. D.C. service; 6-tube operation; A.V.C.; small size)

The following table gives voltages as measured between points indicated and ground:

Tube	Cathode	C.-G.	S.-G.	Sup.-G.	Plate
V1	18	15	110	0	110
V2	2.7	*	110	2.7	110
V3	1	0	-	-	.75
V4 (A.F.)	11	0	115	-	110
V4 (Rect.)	120	-	-	-	120 A.C.

*Depends on applied signal. The above table holds true only when the line voltage is 115 V.

A standard type of output meter should be used and is connected between the amplifier section plate prong of V4 and ground. The signal from the service oscillator must be kept at a low level in order to get below the A.V.C. action.

To align the I.F., first turn the tuning condenser to about 600 kc.—do not ground the oscillator section of the gang condenser. Set

service oscillator to correct frequency and attach to antenna of set. Adjust primary and secondary of both I.F. transformers for maximum gain. Insulated screwdriver and socket wrench are necessary for this operation.

Next, set oscillator at 1,500 kc. Turn gang condenser of set so that the plates are slightly meshed (about 1/4-in.). Adjust trimmers on both sections for maximum signal.

If the coils have been changed it may be necessary to bend plates at 1,000 kc. and 550 kc. Do not bend oscillator plates (rear section) unless absolutely necessary.

The power supply of the set is designed for use on 110 V. A.C. but separate power units are made which supply 110 V. A.C. when connected to 6 V. or 32 V. D.C.

Keep the green wire on the antenna sec-

tion of the gang condenser as far as possible from the oscillator. Keep antenna coil as far as possible from sockets. Keep A.C. power cord clear at the end of chassis. If the set becomes microphonic, push a piece of rubber between speaker and chassis base.

If the D.C. power supply does not deliver the proper voltage (between 110 and 120 V., under the load of the set) the trouble is usually a defective vibrator or the set is drawing abnormal current.

To adjust the speaker remove cover plate from unit. There are 2 screws at each end of the unit within the magnets. When adjusting either pair of screws, one is to be loosened slightly and the other tightened. You will notice that this moves the armature slightly to one side. The air gap at both sides should be the same.

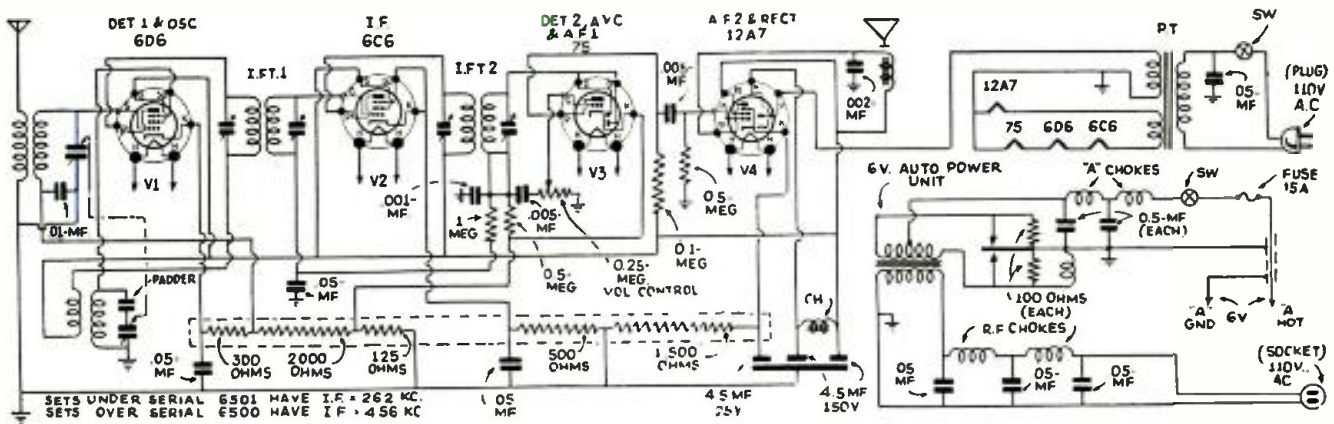

BELMONT MODEL 578 SERIES A (530-1,720 kc.) 5-TUBE A.C. SUPERHETERODYNE

(Dynamic reproducer; A.V.C.; available with transformers for any A.C. line; 7-tube performance; full-vision vernier dial)

Voltages and resistance values (latter in parentheses) for this circuit are shown on the diagram. These voltages are all measured to chassis with a 1,000 ohms-per-volt meter. All tubes must be in their sockets, volume control full-on and the speaker connected. Voltages are measured with 119 V. input to the power transformer.

Transformers are available for universal operation on 40 to 60 cycles and with primary taps for use on 108, 125, 150, 220, and 250 V. Also 25-cycle transformers are made for 105-115 V, or 220 V. primaries, not universals.

When aligning the I.F. transformers, the volume control must be in the maximum position and the gang condenser at the minimum position. Connect the external oscillator to the cap of V2 in series with the "I.F. dummy antenna" and to ground, and align the condensers in I.F.T.2. Move the clip to the cap of V1 and align I.F.T.1, then

check I.F.T.2 again to get an exact setting. The "dummy antenna" is merely a 0.1-mf. condenser in series with the lead to the cap.

The R.F. alignment is accomplished with the oscillator connected to the antenna and ground leads of the set through the broadcast dummy antenna. With the plates of the gang condenser entirely out of mesh, and the service oscillator set at 1,720 kc., adjust the receiver oscillator trimmer (rear of gang condenser). Reset external oscillator to 1,400 kc., turn gang condenser to pick up signal and adjust antenna trimmer to resonance. Next, reset external oscillator to 600 kc., tune signal in, and adjust series padder to resonance, while rocking gang condenser back and forth slightly at the same time to insure correct setting. The padder is accessible from the top of the chassis, and is located between the gang condenser and the power transformer. The dummy antenna for broadcast alignment consists of a 200-mmf. con-

denser and a 20-ohm resistor in series with each other and the external oscillator.

No alignment should be attempted with the chassis in the cabinet. The chassis is held in place by 3 bolts. The knobs are of the pull-off type. The use of a signal generator is an absolute necessity for correct alignment. Beginning with series 5K173250A, the antenna circuit is connected as shown in dotted lines, the solid-line antenna wires being omitted.

Open bypass condensers frequently cause circuit oscillation and distorted tone. The simplest way of finding the defective unit is by shunting each bypass condenser with another of the same capacity until the bad one is found.

Defective or shorted electrolytic filter condensers cause excessive hum, motor-boating, low volume, or a reduction in all D.C. voltages. Open or shorted electrolytic and bypass condensers (across bias resistor of V4) will cause low volume and distorted tone.

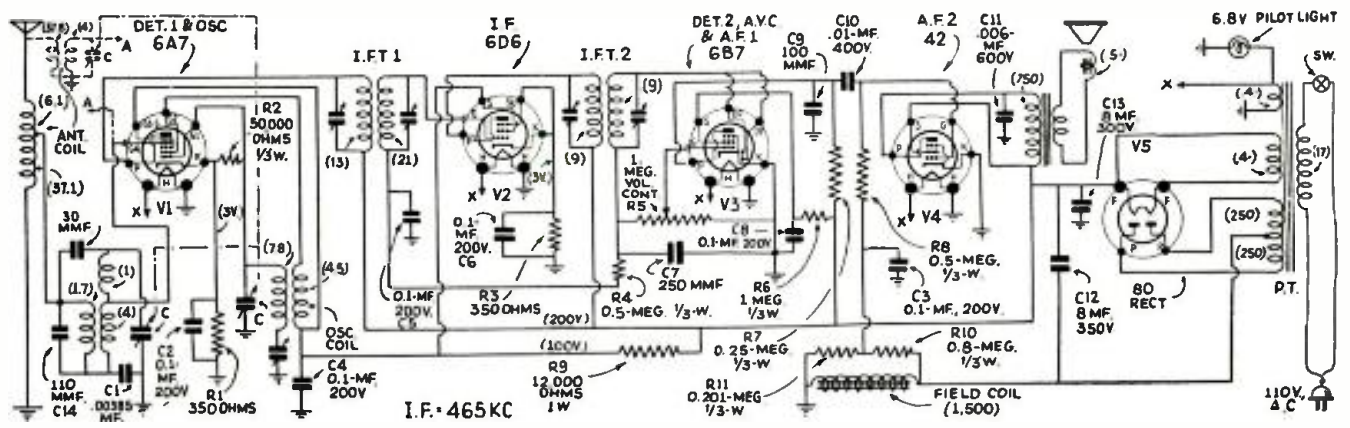

ANALYSES of RADIO RECEIVER SYMPTOMS OPERATING NOTES

Atwater Kent 37, 38, 40, 42. These receivers sometimes develop a very low, distorted, mushy output. There is high grid voltage and low plate voltage on the 71A. In nearly 40 of these sets that have come in with these symptoms, every one showed a shorted condenser, C (Fig. 1A). A .25-mf. replacement may be used.

Philco 90. Several of these sets have come in with the same trouble. Reception would be satisfactory for a while, then suddenly stop. If the A.C. switch was turned off for a short time and then on again, the set would repeat the procedure. The trouble was traced in all cases to an intermittent open in condenser, C1 (Fig. 1 B.). Replacement is made with a .01-mf. unit.

JAMES SHELLER, JR.

Crosley 178. This operating note, we assert, has them all beaten. This set, which is a 2-V. model, came in "dead"—with all tubes burned out! We phoned the owner and he swore the battery connections had not been tampered with. Everything checked OK, so we installed new tubes, hooked it up, and it played all right. We mentally called the owner a liar and turned the thing off, when, bingo!—the tubes went west! We had seen tubes burn out when the set was turned on but never when it was turned off! On some of these sets safety resistor R1 (Fig. 1C.), 0.1-meg., has been omitted—which was the case in this instance; and condenser C (0.5-mf.) we found shorting intermittently, which put the 22½ V. "C" battery across the filaments when the volume control was in the off position.

Victor R32, RE15, R52, and RE75. Some of these models have an unusual amount of hum which evidently is picked up by the 1st A.F. transformer. No amount of additional filtering capacity helps. A 0.1- or 0.15-meg., 1-W. resistor connected between the grids of the push-pull output stage kills the hum every time. It has no appreciable effect on the bass response—at least, no customer has noticed it.

R. M. DAMM

Graybar Model 500. The volume was very poor on this set and only a few locals could be received. The trouble was found to be due to tuning condenser rotors being sprung out of line. As these rotors are non-adjustable the stator plates must be re-set and the set re-balanced (by adjusting the 3 trimmers, which look like part of the chassis assembly, located on the front of the chassis).

WILLIAM HUSARIK

Crosley Model 170-Dual Ten. The set came in with the complaint that there was a steady circuit oscillation, and no reception except by placing a finger on the cap of the first 58 tube. The cause of these symptoms was found to be an open in the R.F. oscillator coil (located back of the band switch).

J. C. McGUIRE

RCA R8 and R12. This set was motorboating badly. The pack condenser 4 mf. unit in the plate-to-ground circuit of the R.F. and det.-osc. plate voltage filter, was found to be faulty. Replacing this on the outside of the pack cured the condition. (The condenser in question has a maroon lead out of the pack.)

Arvin 1935 Car Radio. Should these sets come in for servicing because they have poor quality, volume, etc., examine the plug in the side of the box where the local-distance change is made. The trouble may be due to this unit being loose.

Majestic 15. Noisy and intermittent reception on these sets seem to be common complaints, especially where the climate is very damp. The trouble can be traced in most cases to the I.F. coils; they become corroded, and either fail completely or else the resistance becomes very high. An excellent method of checking this is to charge an 8 mf. condenser and flash each coil. If the coil can stand this test it is in good condition.

Jackson-Bell Peter Pan. The coils of these sets should be inspected as they come in for servicing. The tape used to hold down the windings on the end of the coils seems to be conducive to chemical reaction; as a result, the wire sometimes is completely eaten through.

Grunow 750, 751. A loss of volume, a common trouble on these sets, can generally be traced to a defective volume control.

Grunow 500. Although not shown in the factory diagrams, some of these sets have a hum-bucking coil in the speaker. If the set shows no voltage, check the speaker windings, as, a flash sometimes occurs between the two coils and destroys the leads to the field coil.

Grunow 801. Hum, and a general failure to reproduce properly can generally be traced to a faulty 6B7 tube.

Grunow 501. Hum in these sets is often caused by a faulty filter coil. The laminations come loose and hum badly. Replace with a new coil.

O. K. McCoy

Canadian Westinghouse Models 71 and 61. The set was "dead" upon arrival at the shop. As no diagram was at hand for this particular set, a start was made by checking for voltages. All were low, and there was a negative potential on the plate of the detector (caused by a shorted 2-mf. filter condenser)! Figure 1E shows the location of this condenser in the filter block.

Fada W452X. We have been able to find no circuit diagram for this set, but it will be found to correspond with that of the Westinghouse Model 70. The set overloads in the R.F. section and will be found to give distorted signals in the low-volume position. The cure is to slightly detune the 1st R.F. stage.

L. A. PETERS,
Edmonton, Alberta

Rogers 725A-740A-755A (using spray shield tubes). One common complaint in these sets using the spray shield tubes is a noisy volume control. Replacement did not cure the trouble, however, which was found to be due to gassy tubes. This condition was cured by the addition of a .05-mf. condenser and 0.3-meg. resistor in the grid circuit of the 1st A.F. audio tube. See Fig. 1F.

Another complaint was intermittent reception on all wavelengths. This occurred at the rate of about 60 per minute. The trouble was located in the two .05-mf. condensers located under the tuning condenser shield and connecting the low end of the R.F. coils to the condenser.

R. O'NEIL,
Sault Ste. Marie, Ontario

Victor R32. When the second filter condenser breaks down, replacement may not be necessary. With the reproducer mounted in a large baffle the difference in hum level with or without the condenser was hardly noticeable, and in several cases this unit when broken down has been left out. (This is on 25-cycle line.)

G. M. FOX,
Toronto, Ont.

(Continued on page 572)

CANADIAN NOTES

General Electric and Victor All-Wave Sets. The complaint of inoperation of these sets on either the "C" (20 meter) or "X" (2,000 meter) band is fairly common in these sets (and may occur in other makes of all-wave sets). Sometimes the sets will operate if the switch is snapped hard against the stop. No amount of cleaning or tightening the contacts will give any improvement. Trouble of this sort has been traced to warping of the 7-in. shaft on the wave-change switch (Fig. 1D.) The twist results in the rear switch arm not turning far enough, so that the wrong contact, or in some cases no contact, is made in this section.

W. HOYLE
Coleman, Alberta

Illustrated below are a variety of complaints occurring in various popular receivers. Several Canadian sets are included in the collection.

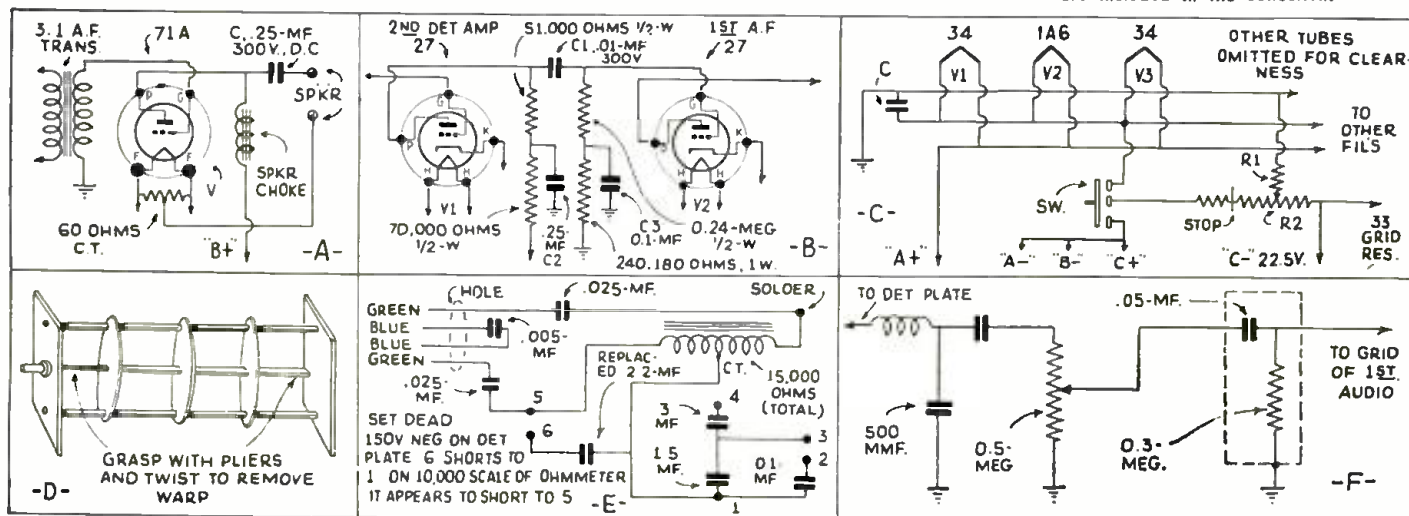

Be Prepared to Meet All Radio Servicing Emergencies WITH GERNSBACK OFFICIAL RADIO SERVICE MANUALS



Just as we say—"Be prepared to meet all radio servicing emergencies with the Gernsback Official Radio Service Manuals." You never know when a service job requires that "extra" special attention. It might mean the difference between doing the job or losing it. You're safe if you have on hand the GERNSBACK MANUALS—either for regular service work or for servicing auto-radios. Get your copy today!

No other radio book is comparable to the new 1935 OFFICIAL RADIO SERVICE MANUAL. In contents, in style of printing, in grade of paper, in illustrations, there has never been published such a comprehensive volume.

This Manual contains over a thousand pages—yet it is only 1 1/4 inches thick because it is printed on a special Bible stock which is an exceptionally good stock, yet one of the thinnest and most durable papers. This 1935 Manual is the most authentic and elaborate service guide ever used in the radio industry.

Contents of the 1935 Manual

Over 1,000 pages full of diagrams and essential information of manufactured receivers—only data of real use in servicing is included. This new Manual is really portable since it is extremely thin and light as well. • Volume V continues where the preceding manual left off. • Many circuits of old sets are included. • Service Men know every set has certain weak points which are really the cause of trouble. Wherever the information could be obtained, these weaknesses with their cures are printed right with the circuits. This is an entirely new and valuable addition to the Manual. • All the latest receivers are included—all-wave sets, short-wave sets, auto-radio sets, midget and cigar-box sets, etc., as well as P.A. Amplifiers and equipment,

and commercial servicing instruments. • The cumulative index is even more complete than before; including cross-references to sets sold under different names and type numbers. • Volume V includes resistance data; socket layouts; I.F. data; and voltage data. • Tube data on latest tubes. • Free question and answer service—as included in our last three manuals.

OVER 1000 PAGES
Over 3,000 Illustrations
Size 9" x 12"—only 1 1/4" thick
Flexible, looseleaf leatherette cover

SET SERVICING
 Service information found in the Manuals covers all types of radio receivers. The material is extremely valuable to Dealers and Service Men. On many diagrams appear voltage readings of tubes, socket connections, transformer data, alignment details, and other service notes.

PUBLIC ADDRESS
 The pages on P.A. Installation will be helpful to Service Men and P.A. specialists. Such prominent features as class A and B amplifiers—single and dual channel systems—attenuators, and mixers—superpower stages—preamplifiers and other commercial devices for P.A. work are included.

ALL WAVE RECEIVERS
 Information relative to short-wave receivers have found their way into the Manuals. For these standard manufactured sets, wherever possible, complete aligning details for all wave bands are included in addition to the service material listed for other sets.

AUTO-RADIO RECEIVERS
 All available service information on new auto-radio sets has been included. From this data alone Service Men could derive sufficient knowledge to venture in a specialty field—that of servicing only auto-radios.

\$7.00
 List

Which of These
GERNSBACK RADIO SERVICE MANUALS
Do You Need to Complete Your Files?

1934 Official Radio Service Manual
 Over 400 Pages. 9x12 Inches.
 Over 2,000 Illustrations
 Flexible, Looseleaf. Leatherette Cover
 List Price \$3.50

1933 Official Radio Service Manual
 Over 700 Pages. 9x12 Inches.
 Over 2,000 Illustrations.
 Flexible, Looseleaf. Leatherette Cover
 List Price \$5.00

1932 Official Radio Service Manual
 Over 1,000 Pages. 9x12 Inches.
 Over 2,000 Illustrations
 Flexible, Looseleaf. Leatherette Cover
 List Price \$5.00

1931 Official Radio Service Manual
 650 Pages (Including Supplements)
 9x12 Inches
 Over 1,500 Illustrations
 Flexible, Looseleaf. Leatherette Cover
 List Price \$4.50
 (Including Supplements)

1933 Official Auto-Radio Service Manual
 (Volume I)
 Over 200 Pages. 9x12 Inches.
 Over 500 Illustrations.
 Flexible, Looseleaf. Leatherette Cover
 List Price \$2.50

—for the real auto-radio servicing "dope," you can't find a better book!

The 1935 Official Auto-Radio Service Manual

Every radio man connected in any way with the booming auto-radio business needs a copy of the new OFFICIAL AUTO-RADIO SERVICE MANUAL. It contains only auto-radio service "dope."

HERE ARE HIGHLIGHTS OF THE 1935 AUTO-RADIO SERVICE MANUAL

240 pages crisscrossed with diagrams, service material and other essential data required for proper servicing of new auto-radio receivers. Included are diagrams of sets which introduced during 1934, and Complete schematic diagrams, chassis layouts, voltage tabulations and servicing instructions are included for practically all sets. "Under-side" tube symbols are also included to facilitate the job of servicing the sets. Instructions are included with many sets telling how to suppress annoying cases of feedback interference. This includes the newest "super-circuits" sets—and what to do when interference is encountered with this type of set. Details on how to make installations in "turret-top" cars are included. The alignment methods used by car makers and set manufacturers are listed with the individual circuits and service information. The index contains the listing of sets which were published in the first edition, as well as the sets which appear in the new volume. This information helps the Service Man to locate the circuit and details for any receiver that has been made. The book is bound in a handy, flexible leatherette cover. To be sure the pages are sturdy to withstand constant use, the book is printed on a special "Bible" stock. This is a very durable, but thin paper. The book printed on this paper can be easily rolled to fit into your pocket or slided in the service kit.



240 Pages
 Over 500
 Illustrations
 Size 9 x 12"
 Flexible, Looseleaf
 Leatherette Cover
\$2.50
 LIST

MAIL COUPON TODAY FOR ANY MANUAL!

GERNSBACK PUBLICATIONS, Inc. RC-336
 99 Hudson Street, New York, N. Y.

Enclosed you will find my remittance of \$ _____ for which please send me promptly, POSTPAID, the OFFICIAL RADIO SERVICE MANUAL indicated.

- | | |
|--|--|
| <input type="checkbox"/> 1935 Edition @ \$7.00 | <input type="checkbox"/> AUTO-RADIO MANUALS |
| <input type="checkbox"/> 1934 Edition @ \$3.50 | <input type="checkbox"/> 1935 Edition @ \$2.50 |
| <input type="checkbox"/> 1933 Edition @ \$5.00 | <input type="checkbox"/> 1933 Edition @ \$2.50 |
| <input type="checkbox"/> 1932 Edition @ \$5.00 | |
| <input type="checkbox"/> 1931 Edition @ \$4.50 (Including Supplements) | |

Name _____

Address _____

City _____ State _____

(Send remittance by check, money order, or register letter if it contains cash, currency or unused U. S. Postage Stamps.)

GERNSBACK PUBLICATIONS, Inc.

99 Hudson Street

New York, N. Y.

OVERSEAS READERS!

These books can be obtained from the following houses:

GREAT BRITAIN

Gorrings, 9a, Green Street, Leicester Square, London, England

FRANCE

Editions Radio, 42 Rue Jacob, Paris

AUSTRALIA

McGill's 183-195, 218 Elizabeth St., Melbourne, C. I

Please Say That You Saw It in RADIO-CRAFT



Only \$13.95

Complete and
GUARANTEED
KIT, \$10.65

DEPENDABLE "RCP" MULTITESTER

Compactly designed for accurate and speedy service. 2000 ohms per volt sensitivity. 3 range ohmmeter, 1/2 ohm to 3 million ohms. 1 range voltmeter, micro-ammeter and milliammeter. Complete with self contained batteries. A superior instrument in every way and moderately priced.

"DEPENDABLE" TUBE & SET TESTER



Ready-to-Use
\$21.95

KIT: \$17.85

This double duty tester tests all tubes as well as shorts and leakages. Tests all types of condensers, makes capacity and ohmmeter tests. 5" full view fan-type "Good-Rad" meter, separate line voltage meter, neon indicating lamp. A piece of equipment every service man needs.

"DEPENDABLE" SHUNTS and MULTIPLIERS ---



SHUNTS for all meters in all ranges. Guaranteed accurate within 1% or 2%. Prices, 2 1/2¢ each; 75¢ each; 1% accuracy 84¢ each, net.

MULTIPLIERS in all standard ranges, accurate within 1% or 2%, 5000 to 10 million ohms. 45¢ to \$2.55 each, net.

KNOBS—Service men's assortment of 15, molded Bakelite, various diameters, all to fit 1/4" shaft. \$1.00

SWITCHES—In all ranges from 3 to 12 points or contacts and in single or multi-range up to 7 gangs. Built for long life and sustained efficiency.

Write Dept. RC-3 for 1936 Test Bulletins

RADIO CITY PRODUCTS CO.
88 Park Place, New York City

7-TUBE SUPER KIT

Kit includes: ANTENNA COIL; R.F. COIL; OSCILLATOR COIL; 1st I.F. COIL; 2nd I.F. COIL; 3-GANG TUNING CONDENSER. Price... **\$1.95**

Schematic circuit diagram for A. C. and Auto Receiver furnished.

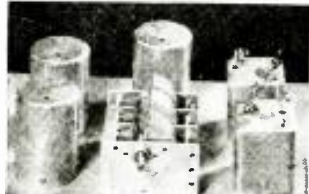

T.R.F. KIT

ANTENNA COIL; 2 R.F. COIL; 3-GANG DEJUR TUNING CONDENSER. Price... **\$1.25**

Write for our special circular radio parts and tubes.
Send enough money for parcel post or we ship by express collect.

ARROW SALES CORPORATION
631 Washington Blvd., Chicago, Illinois

THE "RADIO" BEGINNER

(Continued from page 520)

back very far, to recall the time when it was a veritable stigma on the family crest to admit to aspirations in the radio field—where the height of something-or-other was to be a radio operator aboard ship. Today, though, it is a bit of an honor to be known as a student in radio courses at one of the following institutions (exclusive of specialized schools): New York, Boston, Iowa State, Northwestern, Drake, Kansas State, Western Reserve, and Oglethorpe Universities, and the Universities of Southern California, Denver, Michigan, Syracuse, Rochester and Akron.

TECHNICAL IMPROVEMENTS

Some 10 years ago it was quite OK if a broadcast station wandered either way from its assigned frequency to the extent of 1,000 to 3,000 cycles in the course of a few hours. Today, it's a bad mark against the station if its carrier fluctuates from its assigned position more than a few cycles in a month!

In 1920, a few thousand amateur radio operators listened to the first radio broadcast program—Harding-Cox election returns—over earphones connected to (in most instances) crude, home-made radio sets. Today, 16 years later, over 200,000,000 listeners throughout the world hear broadcast descriptions of world events almost the instant they occur!

In 1920 America had direct cable communication with England and France, in Europe, and with few nations elsewhere. Today, RCA (as an example; there are several others in the field) maintains 56 direct radio circuits that connect the U. S. and its insular territories with 47 countries.

TECHNICAL DEVELOPMENTS

Let us now review some of the more interesting, modern developments in various phases of radio.

Photoradio transmission took another step forward when photographs of speed tests of Major Campbell's *Blue Bird*, instead of being sent first to New York and then to London, were "split." In this scheme the signals leaving Los Angeles were routed to two separate amplifiers, one operating a recorder in New York, and the other actuating a radio transmitter at Rocky Point, L. I., in service with London. By eliminating one relaying step previously necessary, images of much better quality were made available in London simultaneously with New York.

Television in Germany is not going to become a plaything of either commercial or political interests, if the Air Ministry has anything to say about it, according to recent reports, which advise that television has been given into the hands of this administrative branch of the government. *The plan seems to be to develop television as a very important branch of military aviation.*

Uncle Sam has his Grand Island Monitor Station (*Radio-Craft*, February and March, 1932), for policing the American radio "air," but France has gone even further. At Bicetre, just south of Paris, has been installed a listening station having cable connections direct to the French Ministry, which can be advised, within 25 minutes, of any items having special political or other significance picked up anywhere within range of the station. In a specially-fitted room, girls (having a knowledge of shorthand and at least 3 important languages) equipped with earphones sit before silent typewriters. In other rooms, a check is kept on foreign musical programs, and on French broadcasting generally; and one room is reserved for the private use of the Minister.

Do not be surprised to hear an "American" program coming over your favorite station in Canada, Mexico, Cuba or Puerto Rico. This may occur 'most any day, if FCC grants NBC's request to permit RCA recordings of programs, "—on cylinders, metal or translucent film, or other media, as well as electrical transcriptions," to be shipped to broadcast stations in these several countries.

Recent research work at the headquarters laboratory of the American Radio Relay League, reports Ross A. Hull, associate editor of *QST* and director of the work, indicates that atmospheric humidity, or some accompanying factor, has a pronounced influence on the performance of wavelengths in the neighborhood of 5 meters. When the humidity is high—short of actual

rain—in the atmosphere between two points, communication will be very much better than when the air is dry. The reliability of contact—even to record-breaking distances—can thus be predicted in advance.

A development which in 3 years has precipitated an avalanche of radio set business is "all-wave" reception, as the figures indicate: prior to 1933 there were available very few sets of all-wave type; by the end of 1933 the figure had jumped to 500,000, and today it is estimated that there are about 5,000,000 all-wave sets in the U.S., with production for 1936 geared to double the 1935 production!

International broadcasting, which until now has been mostly a private matter, is rapidly changing aspect. Nations are now making bids for attention by other countries. Short waves, directive antennas, higher power and perfected equipment now enable Japan, Germany, England and Russia to drop a "radio barrage" on the U.S., while Uncle Sam is proceeding with equivalent plans in relation to South American countries (see page 518).

The following items indicate some of the more unusual applications of radio.

NOVEL USES OF RADIO FACILITIES

The house of James McCreery & Co. stole a march on its competitors when its Paris millinery buyer commissioned a fashion artist to accompany her to exclusive openings of Paris designers. Fall-style sketches by the artist were hurried to a plane headed London-way. Upon arrival there, the sketches were put on the RCA photoradio circuit to America; it took only 20 minutes to complete the reproduction at Riverhead, L.I. The idea is soon to be applied to other lines of merchandise.

Through its (resumed) weekly "Northern Messenger Service" to the northern outposts of Canada, the Canadian Radio Commission relays messages from relatives and friends in many parts of the world, to residents scattered throughout the Arctic. In the past, it took many months for people to communicate with those in the remote regions of Canada.

We have it on the word of none other than Professor Caligizari, of Rome University, noted phrenologist, psychiatrist, and creator of the new technique for experimenting on the human brain, that there is the possibility of exchange of sensations and possibly ideas between two people placed quite a distance apart, and that these are due to emanations which are substantially miniature radio waves.

RADIO IN PERSPECTIVE

"Radio—the most active and profitable business in the world," read the prospectus of a radio school, nearly 10 years ago. The intervening years have proven that the statement is gilt-edge fact.

David Sarnoff, who is president of RCA, and who has just returned from a trip to Europe, has put it this way: "What is ahead of American industry is more important than what is behind it. Throughout the years of the depression engineers have worked steadily in American laboratories, and their labor is bound to bear fruit. Research is the builder of technical advances and the creator of new industries. Research, in which the United States is leading the world, is paving the way for the industrial revival. Signs of the upturn already are visible in the radio industry..."

A section of the French reception center with switch-board to the Postmaster's office.



Please Say That You Saw It in RADIO-CRAFT

TECHNICIANS' DATA SERVICE

JOSEPH CALCATERRA DIRECTOR

A special arrangement between RADIO-CRAFT magazine and the publishers of this literature, which permits bulk mailings to interested RADIO-CRAFT readers, eliminates the trouble and expense of writing to each individual organization represented in this department.

2. HAMMARLUND 1936 CATALOG. Contains 12 pages of specifications, illustrations and prices on the new line of Hammarlund variable, mid-gate, band-spread and adjustable condensers; trimming and padding condensers; R.F. and I.F. transformers, coils and coil forms; sockets, shields, chokes and miscellaneous parts for ultra-short-wave, short-wave and broadcast operation.

3. HOW TO GET A HAMMARLUND 1936 SHORT-WAVE MANUAL. A circular containing a list of contents and description of the new 16-page Hammarlund Short-Wave Manual, which contains construction details, wiring diagrams, and list of parts of 12 of the most popular short-wave receivers of the year.

4. THE "COMET PRO" SHORT-WAVE SUPERHETERODYNES. Describes the outstanding features of the standard and crystal-type Hammarlund "Comet Pro" short-wave superheterodynes designed to meet the exacting demands of professional operators and advanced amateurs for a 15 to 250 meter code and phone receiver, but which can be adapted by anyone for laboratory, newspaper, police, airport and steamship use.

5. ELECTRAD 1936 VOLUME CONTROL AND RESISTOR CATALOG. Contains 12 pages of data on Electrad standard and replacement volume controls. Truvalt adjustable resistors, vitreous wire-wound fixed and adjustable resistors and voltage dividers, precision wire-wound non inductive resistors, center-tapped filament resistors, high-quality attenuators, power (50- and 150-watt) rheostats and other Electrad resistor specialties.

57. RIBBON MICROPHONES AND HOW TO USE THEM. Describes the principles and operating characteristics of the Amperite velocity microphones. Also gives a diagram of an excellent humless A.C. and battery-operated preamplifier.

62. SPRAYBERRY VOLTAGE TABLES. A folder and sample pages giving details of a new 300-page book, containing 1,500 "Voltage Tables" covering receivers manufactured from 1927 to date, published by Frank L. Sprayberry to simplify radio servicing.

64. SUPREME No. 385 AUTOMATIC TESTER. A technical bulletin giving details, circuits and features covering this new Supreme development designed to simplify radio servicing. In addition to the popular features of Supreme analyzers and tube testers it contains many direct-reading features which eliminate guesswork or necessity of referring to charts or tables.

67. PRACTICAL MECHANICS OF RADIO SERVICE. Information, including cost, features and outline of lessons of the Frank L. Sprayberry course in Radio Servicing, and list of Sprayberry Data Sheets for modernizing old radio equipment.

73. HOW TO ELIMINATE RADIO INTERFERENCE. A handy folder which gives very complete information on how to determine and locate the sources of radio noise by means of the Sprague Interference Analyzer. A description of the analyzer and method of using it is included, together with data on how to eliminate interference of various kinds once the source is located.

74. SPRAGUE 1936 ELECTROLYTIC AND PAPER CONDENSER CATALOG. Gives specifications, with list and net prices on a complete line of wet and dry electrolytic, and paper condensers made by the Sprague Products Co. for radio Service Men, set builders, experimenters and engineers. Information on the Sprague Capacity Indicator, for making capacity tests on condensers and in servicing receivers, is included.

75. SPRAGUE TEL-U-HOW CONDENSER GUIDE. A valuable chart, compiled by the Sprague Products Co. which tells the proper types, capacity values and voltages of condensers required in the various circuits of radio receivers and amplifiers, and how to locate radio troubles due to defective condensers. Includes data on condenser calculations.

76. FACTS YOU SHOULD KNOW ABOUT CONDENSERS. A folder, prepared by the Sprague Products Co., which explains the importance of various characteristics of condensers, such as power-factor, leakage, capacity and voltage in determining the efficiency or suitability of a given condenser to provide maximum filtering and safety in operation.

77. SUPREME 391 P.A. ANALYZER. This booklet describes the features and use of the new Supreme 391 P.A. Analyzer, designed to equip the radio Service Men to cash in on the constantly growing opportunities for service in the sound equipment and public address systems used in movie theatres, schools, churches, auditoriums, etc.

"PULL-PUSH" MOISTURE-PROOFING FOR TRANSFORMERS

(Continued from page 530)

right is shown sealed and loaded with preheated coils which have been transferred from the dehydrating ovens.

The tank at left-front shows the load of coils after they have been thoroughly impregnated, where they are drained of the excess hot wax and allowed to cool.

Between the two tanks are shown the heavy pressure and high-vacuum control valve. At the bottom is the hot wax-supply pipe and control valve.

On the bench in the foreground are shown a load of transformer coils, after having been "pull-push" impregnated and a-sorted, ready for transferring to the several assembling departments.

This article has been prepared from data supplied by courtesy of General Transformer Co.

FREE TO SERVICEMEN

For a limited time



VALUABLE Service Data PRACTICAL Sales Helps

To enable a larger number of servicemen to become familiar with the advantages of RADIO MANUFACTURERS SERVICE, we will send FREE to any serviceman . . . on receipt of the coupon below filled out . . . a sample copy of one of the recent mailings of service information and service selling aids.

These are being sent every month from R.M.S. headquarters to every member of this nation-wide service organization. Over 15,000 members and still growing! Send in the coupon . . . see what you have been missing! Full details of Radio Manufacturers Service will also be sent you.



RADIO MANUFACTURERS SERVICE

Send in This Coupon TODAY!

Date.....

R.M.S. Headquarters,
Tioga & C Sts., Philadelphia, Pa.

Please send, without obligation to me, FREE sample of R.M.S. mailing and full information on Radio Manufacturers Service.

Name

Address

Radio-Craft Technicians' Data Service
99 Hudson Street.
New York City, N.Y. RC-336

Please send to me, without charge or obligation, the catalog, booklets, etc. the numbers of which I have circled below.

2	3	4	5	57	62	64
67	73	74	75	76	77	

My radio connection is checked below:

- Service Man operating own business.
- Service Man for manufacturer.
- Service Man for jobber.
- Service Man for dealer.
- Service Man for servicing company.
- Dealer.
- Jobber.
- Experimenter.
- Professional Set Builder.
- Amateur Set Builder.
- Short Wave Work.
- Licensed Amateur.
- Station Operator.
- Radio Engineer.
- Laboratory Technician.
- Public Address Worker.
- Manufacturer's Executive.
- Student.
-

I am a:

- Subscriber
- Newsstand reader

I buy approximately.....of radio material a month. (Please answer without exaggeration or not at all.)

Name

Address

City..... State.....
(Please print name and address)

Avoid delay. The catalogs and booklets listed are now in stock and will be sent promptly as long as the supply lasts. Please use this coupon in ordering. The use of a letter causes confusion and delay.

Please Say That You Saw It in RADIO-CRAFT

Now—a high-powered—

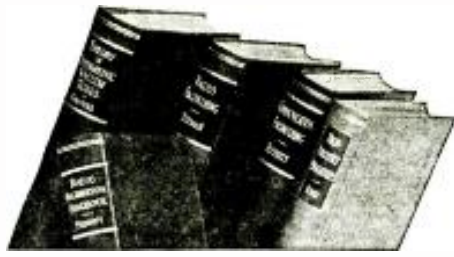

Radio Engineering Library

—especially selected by radio specialists of McGraw-Hill publications

—to give most complete, dependable coverage of facts needed by all whose fields are grounded on radio fundamentals

—available at a special price and terms.

These books cover circuit phenomena, tube theory, networks, measurements, and other subjects—give specialized treatment of all fields of practical design and application. They are books of recognized position in the literature—books you will refer to and be referred to often. If you are practical designer, researcher or engineer in any field based on radio, you want these books for the help they give in hundreds of problems throughout the whole field of radio engineering.

5 volumes, 2981 pages, 2000 illustrations

1. Everitt's COMMUNICATION ENGINEERING
2. Terman's RADIO ENGINEERING
3. Chaffee's THEORY OF THERMIONIC VACUUM TUBES
4. Hund's HIGH FREQUENCY MEASUREMENTS
5. Henney's RADIO ENGINEERING HANDBOOK

10 days' examination. Special price. Monthly payments. \$26.00 worth of books cost you only \$23.50 under this offer. Add these standard works to your library now; pay small monthly installments, while you use the books.

SEND THIS ON-APPROVAL COUPON

McGraw-Hill Book Co., Inc.
330 W. 42nd St., New York, N. Y.

Send me Radio Engineering Library, 5 vols., for 10 days' examination on approval. In 10 days I will send \$2.50. Plus few cents postage, and \$2.00 monthly till \$23.50 is paid, or return books prepaid. (We pay postage on orders accompanied by remittance of first installment.)

Name.....
Address.....
City and State.....
Position.....
Company..... RC-336

ELECTRIC DRILL



CAPACITY
1/4" DRILL
Weight 4 1/2 lbs.
PRICE
\$5.97

The Utility Drill is built for intermittent service, always ready for instant use, and will accommodate straight shank drills up to 1/4 inch. Weighs only 4 1/2 pounds, and has a convenient on-and-off switch mounted on the motor body. The three-jaw chuck has a capacity up to 1/4 inch. Furnished complete with 10 feet of heavy duty rubber covered cord, and plug cap. Operates on alternating current only. 110 volts, 60 cycles. Ship. weight 5 lbs.

Our Old Customers Know That Our Merchandise Is Sold on a Strict Money-Back Guarantee

All Shipments will be forwarded by Express Collect if not sufficient postage included with your order.

WELLWORTH TRADING CO.
560 W. Washington Blvd., Dept. RC-336, Chicago, Ill.

THE THEORY OF F.C.T.

(Continued from page 521)

phenomenon is shown by Fig 1B, where the current curves of the plate and screen-grid circuits are shown as a function of the plate potential. It can be seen from these curves that the balancing effect can be used for detection; but the system would present few advantages over those already in use.

If, however, the set-up shown in Fig. 2A is used, in which a resistance, R, is introduced into the plate circuit between the control-grid and the filament, the effectiveness of the detector will be notably improved. In fact, in applying small variations of potential in A, the current circulating through the plate (when it is positive) passes through resistance R, causing a difference of potential, which renders the control-grid more negative. The screen-grid current is thus lowered to a noticeable extent, and this lowering is added to, or mixed with that which was noticed in the first trials and shown graphically in Fig. 1B.

It seems, then, that a most sensitive detector-amplifier could be made by this method. Practical experience confirms the idea! In the diagram, Fig. 2B, the radio-frequency oscillations are picked up by induction in coil S, which may be the secondary of an R.F. or I.F. transformer. The ends of this tuned coil are connected to the plate and the control-grid. The latter is connected to the negative side of the filament or to the cathode—by means of a resistance, R, shunted by condenser C.

The oscillations, which affect the coil S, vary the potential of the plate; only positive alternations giving rise to a detection current. This current passes through the resistance R and causes a difference of potential which is variable in value, but always in the same direction, thus making the control-grid always negative. To sum matters up, this grid plays the role of a very sensitive low-frequency relay.

The condenser C, (which is very small—at the most 30 mmf.) permits the residual high-frequency current to leak off. The resistance R, which may be variable, can be used to regulate the volume. This resistance cannot have more than 50,000 ohms! For a signal of medium power it will be reduced to a value very much lower than this limit; while, for very powerful signals a few thousand ohms are sufficient. The value will depend more or less upon the R.F. or I.F. amplification which precedes it.

Thus, the time constant for C x R is absolutely negligible, not to say practically nullified, since it is 10 or 20 times less than that for the commonly used detector systems.

However, a high-frequency potential which cannot altogether be neglected appears on condenser C in spite of the low value of R. This high-frequency current is also detected, but it is interesting to note that this phenomenon takes place in a favorable direction, since it definitely assists in still further augmenting the current which is flowing in the screen-grid circuit.

Compared to the diode-detection method, this new system has the advantage of presenting a much higher input resistance to R.F. currents and as a result presents less damping to the flow of R.F. currents, thus improving selectivity. Moreover, in a diode detector (as a result of the high resistance introduced into the detection circuit) an e.m.f. of opposite direction to the signal current is produced in the resistance opposing it and reducing to a notable degree the sensitivity of the system. In the device which we have just described very little resistance is introduced and, therefore, this effect is much less noticeable.

Fig. 2, below. The experimental circuits for determining F. C. T. action.
Fig. 3, right. Using the type 57 as an F. C. T. detector.

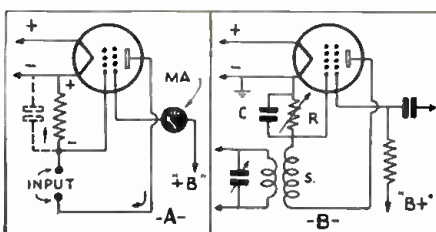

To summarize: this new method of detection adds to the sensitivity of grid detection the fidelity of plate detection, at the same time presenting the flat characteristic of diode detection, and all this without decreasing the power handling capacity which remains superior to that of any of the other methods.

This method of detection is capable of giving very good quality of reception, on the condition, of course, that distortion in the amplifier stages is avoided.

It is even possible to use a "reflex" arrangement in this circuit; that is, one in which the same tube serves both as an R.F. amplifier and as F.C.T. detector.

It is also interesting to use a screen-grid tube having a suppressor-grid in order to increase the internal resistance. (It must be remembered that the published characteristics for a tube are no longer correct when the screen-grid is used as the anode.)

In using the second or center grid as the screen-grid in a type 57 tube, with the rest of the hook-up remaining the same, the results are excellent, the power capacity being even greater. Figure 3 shows the hook-up to use in such cases. It is necessary to note that the potential of the screen-grid is very critical and should generally be set at a third of the voltage of the anode (suppressor-grid).

The 57 connected in this way is not only the best to use in a reflex hook-up, but can also be used without difficulty in a frequency-changer.

F.C.T. detection can be applied in a particularly advantageous manner to battery sets for which there are no specially-designed diode tubes.

(Toute La Radio in which this detection system was first described is conducting some qualitative tests of the performance in order to verify in detail the inventor's findings.—Editor.)

A BEGINNER'S SET USING THE NEW "F.C.T." DETECTION SYSTEM

(Continued from page 521)

the low-potential end of the L2 secondary. This is not an error but is part of the scheme of operation; it is in accordance with the more detailed explanation of F.C.T. circuit operation that appears elsewhere in this article.

In order to bring out the fact that there are no great complexities to this receiver the following analysis of the functions of the remaining components is given.

STANDARD PRACTICE

Bypassed resistors R4, R9 and R12 in the cathode circuits of V1 to V3 develop bias voltages to the respective tubes. Components R7 and R10 are respectively plate R.F. load and screen-grid A.F. load resistors. Resistor R11 is the control-grid A.F. load for V3. Resistor sections R5-R6 and R2-R3 constitute voltage dividers, the taps between each two resistors supplying screen-grid voltages.

Condenser C4 is an R.F., and C6, an A.F., coupling unit. Condenser C7 is a harmonic bypass unit and its value will vary with individual types of output tubes and output load (headphones, A.F. transformer, primary, etc.).

EXPERIMENTAL VARIATIONS

To compensate for variations in tube characteristics the experimenter is recommended to try the use of a potentiometer of about .1-meg. resistance in place of R5-R6, and a .1- to 0.5. meg. potentiometer in place of resistors R2-R3. Resistor Rx, shown in the photos and not

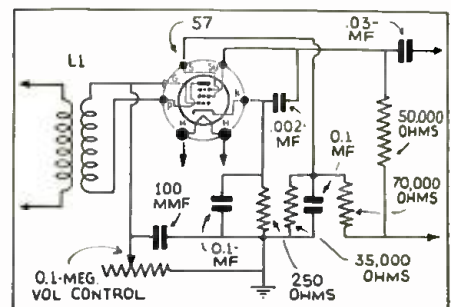

Please Say That You Saw It in RADIO-CRAFT

in the schematic, was added experimentally and may be used, or not, as desired. This is an 0.5-meg. potentiometer, connected in series with C7, at X. An R.F. choke may be tried in place of R7.

Although a value of 0.1-meg. is indicated for potentiometer R1, the experimenter may find that somewhat better control is afforded by using a potentiometer of lower value—probably, not less than about 25,000 ohms.

Three tubes were utilized in this receiver only because this was the minimum number permissible for adequate demonstration of F.C.T. detection in a local-station broadcast receiver. Detector V2 will very nicely handle considerably greater signal-frequency input; in fact, improved operation of this detector circuit will be secured if an additional stage of R.F. amplification is used. A.F. output tube V3 will give excellent signal output for headphone operation; for "decent" loudspeaker operation, though, a second stage of A.F. amplification would be in order—preferably, a push-pull circuit should be utilized here, in order to maintain the high-quality audio output of which this receiver is capable.

Due to the fact that this circuit is so new, not all of its peculiarities are as yet known. However, the experimenter will learn a great deal in connection with this idea, by trying out other values for the circuit of V2.

LIST OF PARTS

- One special wholesale Radio Service iron-core antenna coil, L1;
- One special wholesale Radio Service iron-core detector coil, L2;
- One wholesale Radio Service 2-gang condenser, 350 mmf., ca. cb;
- One Cornell-Dubilier condenser, 100 mmf., C;
- Four Cornell-Dubilier condensers 0.1-mf.; C1;
- One Cornell-Dubilier condenser, 0.5-mf., C2;
- One Cornell-Dubilier electrolytic condenser, 25 mf., C3;
- One Cornell-Dubilier mica-dielectric condenser, 200 mmf., C4;
- One Cornell-Dubilier condenser, .001-mf., C5;
- One Cornell-Dubilier condenser, .05-mf., C6;
- One Cornell-Dubilier condenser, .002-mf., C7;
- One Electrad wire-wound pot., 0.5-meg., Rx;
- One Electrad carbon potentiometer, 0.1-meg., with switch, R1. Sw.;
- Three I.R.C. resistors, 0.5-meg., R2, R3, R11;
- One Aerovox bias resistor, 650 ohms, R4;
- Two I.R.C. resistors, 50,000 ohms, R5, R6;
- One I.R.C. resistor, 75,000 ohms, R7;
- One I.R.C. resistor, 5,000 ohms, R8;
- One Aerovox bias resistor, 250 ohms, R9;
- One I.R.C. resistor, 0.1-meg., R10;
- One Aerovox resistor, 750 ohms, R12;
- One 5-post terminal strip;
- Two 2-post terminal strips;
- One dial;
- Two knobs;
- One Blau aluminum chassis, size 7x14x1 ins. high;
- One Blau aluminum panel, size 7x15 ins. long;
- One RCA, Sylvania or Raytheon metal tube, type 6K7, V1;
- One RCA, Sylvania or Raytheon metal tube, type 6J7, V2;
- One RCA, Sylvania or Raytheon metal tube, type 6F6, V3;
- Three Bud wafer sockets, for V1, V2 and V3;
- Miscellaneous hardware.

USEFUL CIRCUIT IDEAS

(Continued from page 529)

proved very satisfactory. The greatest problem was to get a good transformer and vibrator.

The rear view of the chassis of the set.

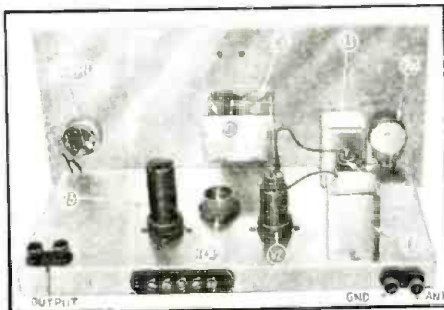

THE LAST STEP in TUBE TESTER DESIGN

EMISSION TESTERS

MUTUAL CONDUCTANCE

COMPOUND CIRCUITS

DYNAMIC MU CONDUCTANCE

POWER OUTPUT

by

TRIPLETT

MODEL 1500 \$36.67

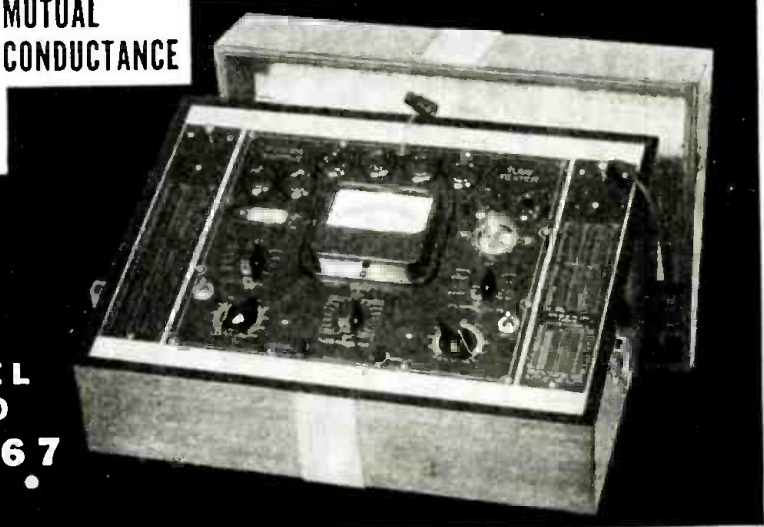

The power output circuit by Triplett is the last step in Tube Tester Design. This circuit checks all types of tubes under load, approximating actual conditions in a radio set. Visit your nearest Triplett jobber and see for yourself how this checker catches those defective tubes you had so much difficulty in locating.

Model 1500 tests all types of radio tubes; glass, metal or glass-metal on the power output circuit. Housed in attractive modernistic case with removable cover, suitable for portable or counter use. Dealer Net Price...\$36.67

Model 1501, the new Triplett Multi-Purpose Tube Tester, combines 10 instruments in one. Housed in same case as 1500. Dealer Net Price...\$46.67

TRIPLETT MANUFACTURES

a complete line of electrical measuring instruments for radio, electrical and general industrial purposes both standard and custom built. See them at your jobbers. If you have an electrical instrument problem, write to TRIPLETT.



MAIL THIS COUPON

Triplett Electrical Instrument Company
163 Harmon Drive, Bluffton, Ohio
Please send me your new 1936 Catalogue.....

Name

Address

City State

A push-pull output transformer is used and the vibrator is a relay taken from a Majestic eliminator and trickle charger. The diagram, Fig. 10 A, is self-explanatory. The vibrator is adjusted for peak output which is about 150 V.

and 17 ma. The circuit of Fig. 10B may be used where the circuit requires higher voltage and less current than that at A.
MAX KELLMAN

The underside of the chassis showing position of condensers, resistors, etc.

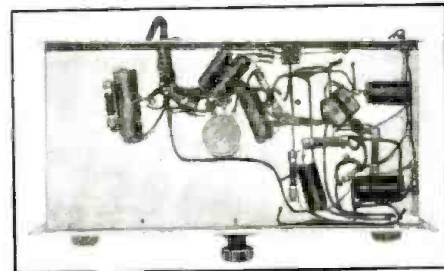

The following circuit, although not a reader's contribution, is printed in the belief that it may be of interest to the experimenter.

MAGNETIC-LEAKAGE THICKNESS GAUGE.
This "Electric Gauge Indicating Unit" made by G.E., and shown in Figs. 11 and 12, is used to gauge the thickness of non-magnetic coating on any magnetic metal. An example would be its use for measuring thickness of enamel on steel plates. The gauge head constitutes an open magnetic circuit which the metal sample partially closes. The voltage variation as the gauge-head inductance value changes, is measured by the rectifier-type meter, M. An adjusting choke (balancing coil) is provided to secure various pre-set conditions of the meter.

Please Say That You Saw It in RADIO-CRAFT



when Trouble 'hears
it's ugly head'

and the customer starts talking in three-letter words it's time you got wise to yourself and changed to CENTRALAB. Noisy, nerve-teasing reception can very often be permanently cured with a dose of "One Centralab Radiohm to one Radio." It works miraculous cures. Try it next time you're out Trouble shootin'. . . and a mere handful service practically any set made . . . better than ever before.

Every Radio Service Man should be a member of the Institute of Radio Service Men



Centralab
MILWAUKEE WIS.
RADIOHMS SUPPRESSORS
FIXED RESISTORS

SEND FOR THIS
FREE
CATALOG

Check full of BARGAINS in RADIO SETS, Long and Short Wave Apparatus, Servicemen's Repair and Replacement Parts, Electrical Appliances and hundreds of Miscellaneous Specials at THE UNENDING SAVINGS. Get this big new Bargain Book. It's absolutely FREE without obligation—just send us your Name and address on a post card.

RADIO CIRCULAR CO., INC.
915 Broadway, Dept. R. C., New York, N. Y.

Bargain Bulletin
RADIO CIRCULAR
LATEST ISSUE Just Out

MILLION TEST EQUIPMENT
\$845 NET

Tests:
1. Emission
2. Metal Tubes
3. Shorts
4. Leakage
5. Resistance
6. Electrolytics
7. Bypass Condensers
8. Neon Alignment

Send 20% deposit with sample order. Balance C.O.D., F.O.B. factory.

MILLION RADIO & TELEVISION LABS.
361-99 W. Superior St., Chicago

THE LATEST IN TUBE DEVELOPMENTS

(Continued from page 524)

that they have a more dependable degree of vacuum than the original metal tube; lower operating temperatures permitting closer arrangement of chassis components; and more rugged structure eliminating microphonics.

6Q7 Coronet Duo-Diode Triode. This tube is similar in characteristics to the glass type 75. The triode-section amplification factor is 70. By using a 3 V. "C" bias instead of 2 V. the possibilities of positive grid current are minimized.

6X5 Coronet Full-Wave Rectifier. This is an indirect-heater type of tube for automotive use. Its characteristics are similar to the type 84.

The coronet series is now in production in the following tubes: 5Z4, 6A8, 6C5, 6F5, 6F6, 6H6, 6J7, 6K7 and 6L7. All have octal bases.

6X5 Full-Wave Rectifier. This type tube (as well as those which follow) has been announced by Sylvania, Raytheon and RCA as being available in their regular metal tube series. Although designed especially for use in automobile receivers in place of the 84 it may also be utilized for compact A.C. operated receivers where the rectifier current drain does not exceed the maximum output current rating of the tube.

Tentative Ratings and Characteristics:
Heater Voltage (A.C. or D.C.)—6.3 V.
Heater Current—0.6 A.
A.C. Voltage per Plate (r.m.s.)—350 V. Max.
D.C. Output Current—75 ma. Max.
Peak Inverse Voltage—1,250 V.
Peak Plate Current per Plate—375 ma. Max.
Voltage between Heater & Cathode—400 V. D.C. Max.

In order to obtain satisfactory output and regulation, careful consideration should be given to proper filtering. Filter circuits of the condenser-input or the choke-input type are applicable.

The D.C. output will be considerably greater with a condenser-input filter than when the other type is used. Also, it will be true that higher peak plate currents will be encountered. The first condenser in the filter circuit, therefore, should not be too large in capacity. It is not likely that the A.C. input voltage will be a pure sine waveform so that the instantaneous peak values may be considerably greater than 1.4 times the r.m.s. value.

When used with a vibrator and transformer combination as a source of A.C., considerable care must be taken in the transformer design, as well as the filter design, to avoid exceeding any of the maximum ratings.

25A6. This metal tube corresponds to the type 43. Characteristics are as follows:

Class A Amplifier Operating Conditions and Characteristics

Plate	95	135	180 max. V.
Screen-grid	95	135	135 max. V.
Control-grid	-15	-20	-20 V.
Amplification Factor	90	99	96
Plate Resistance	45,000	42,000	40,000 ohms
Mutual Cond.	2,000	2,350	2,400 mmhos.
Plate Current	20	39	40 ma.
Screen-grid Current	4	8.5	8.0 ma.
Load Res.	4,500	4,000	5,000 ohms
Power Output	0.9	2.0	2.75 W.
Dist.	11%	9%	10%

25Z6 Rectifier. This metal tube corresponds to the glass type 25Z5 tube.

Operating Conditions and Characteristics:
A.C. voltage per plate—125 V. max.
D.C. load current as voltage doubler—85 ma. max.
D.C. load current as rectifier—85 ma. max.
Peak plate current—500 ma. per plate

Type 25Z6 is used as the rectifier in power-supply applications where a transformer is not employed. Condenser-input type filters are recommended for use with this tube in order to obtain a D.C. output voltage as high as possible.

Tests on R.F. coil efficiency have shown that the Q of a really good coil is reduced by an undesirable amount when connected across the control-grid and shield of the metal R.F. amplifier or mixer tubes if certain types of phenolic insulation are used.

To reduce these losses, the engineers in the Raytheon radio tube laboratory, tested all available types of insulation material including ceramics. The material finally selected was developed during the tests. It has the mechanical strength of the strongest material previously used but is near the best ceramic in low losses at the high frequencies.

INSTRUMENT NEEDS OF THE BEGINNER IN SERVICING

(Continued from page 524)

each tube and an actual mutual conductance tester would be far too complicated and, particularly, far more expensive than most of the testers now built for service use.

The method of tube testing used by at least one tester manufacturer is the "emission" type, which is a practical, commercially feasible method.

In this tube tester, all elements except the filament and cathode are placed at a positive potential with respect to the cathode-filament. By incorporating a D.C. milliammeter in the cathode circuit and sufficient resistance to obtain a comparatively correct load, a reading of the total emission current may be obtained on the meter. As the emission current of a tube is dependent on the emitting qualities of the cathode and falls off as the life of the tube depreciates, we obtain a very satisfactory tube testing procedure.

The third service instrument necessary to a complete radio shop is the signal generator or R.F. oscillator. This is used for alignment purposes and acts as a miniature radio transmitter. It is usually connected to the radio receiver under test according to the instructions issued by each radio manufacturer and should be sufficiently accurate to align all modern receivers.

The unit shown uses harmonic coverages of the higher frequencies from 10 mc. (30 meters) to 30 mc. (10 meters) with complete fundamental coverage of intermediate and broadcast frequencies from 100 kc. (3,000 meters) to 10 mc. Harmonic coverage of the higher frequencies is used for greater accuracy as the calibration of signal generators offering higher frequency fundamentals than 10 mc. is often found to change considerably with slight changes in the materials and tubes used. This is particularly noticeable when replacing tubes originally delivered with such a signal generator.

This signal generator as the diagram shows is of the electron-coupled circuit type having a directly calibrated airplane dial, accurate adjustment being effected by means of "trimmer" condensers. It can be used either modulated or unmodulated, having a self-contained A.F. oscillator which modulates the R.F. carrier about 50 per cent and produces a 400-cycle beat note.

One point more should be noted in the purchase of a signal generator. The R.F. output should be fully controllable so that attenuation of the complete generated output can be accomplished, not as in some instruments on the market an attenuation of the A.F. component only which is but a control of the percentage of modulation from zero to maximum percentage. In the instrument illustrated, the R.F. carrier output is attenuated by means of a ladder-type attenuator with a Multiplier switch and a variable control calibrated in relation to the signal output in Microvolts.

When the novice in radio servicing has purchased and mastered fully the use of the foregoing three instruments, then, and only then, is he able to judge what other instruments are necessary to his complete service shop.

Cathode-ray equipment, meggers, vacuum-tube voltmeters, resistance, inductance and capacity bridges are all fine pieces of laboratory equipment, but the Service Man should first gain a thorough knowledge of his tube tester, analyzer and signal generator before dabbling in special equipment.

There is one other addition to the Service Man's shop which no manufacturer sells. It can't be bought but it can be used—common sense! The writer ventures a conjecture that more sets have been fixed through the use of one or more of the three foregoing instruments *plus common sense* than have been made operable by the use of some special laboratory equipment in the hands of an inexperienced operator.

Therefore—
1—Know your weak points especially and strive by study to better your theoretical and practical radio knowledge.

2—Know your instruments—your test instruments are your electrical eyes, ears and nose. Learn to use them to the utmost advantage.

3—Know your radio sets—you can't remember them all; get a good set of service manuals—they will be an invaluable aid.

4—Use your head—it always pays a man to think.

This article has been prepared from data supplied by Supreme Instruments Corp.

Please Say That You Saw It in RADIO-CRAFT

MAKING A 5-METER MIDGET PORTABLE RADIO STATION

(Continued from page 525)

the manufacturer, but a simple strap of 1/16-in. aluminum around the outside is sufficient. The gridleak is 1 meg. and of the smallest size available. It is supported by the wiring. The .01-mf. condenser across is a flat unit which fits in just above and at one side of the transformer. The on-off switch is a small toggle unit with short neck.

This completes the transmitter, and if it has been made properly, it will only be necessary to hook it up, turn it on and it will "perk." Circuit oscillation may be checked by connecting a milliammeter of about 0-5 ma. scale in series with the "B+" lead. It should read about 2.5 ma. when the circuit is oscillating, and when a finger is placed on the grid or plate socket terminal the meter reading should jump to 3 ma., or so.

The receiver differs from the transmitter only in that an interruption-frequency coil is used instead of the "mike" transformer. This is wound on a form made of fibre washers on a brass screw. The center washers are 5/16-in. in dia. while the large ones are 1 1/8-in. The space for the secondary is 3/8-in. wide, while that for the primary is 7/32-in. wide. The wire is No. 34, enamel-covered and the winding is easily done if the screw which holds the form together is held in a hand drill, the drill in turn being held in a vise.

The receiver is quite simple to set into operation, the only trick being to secure proper super-regeneration. This is governed entirely by the I.F. coil, and by the condenser C6 across the secondary. If a low-pitched buzz is heard in the phones, more capacity is needed across the secondary. Operation of both units is simplicity itself. Just snap the switch, and tune. The hiss of the receiver will disappear when a strong signal is tuned-in.

The type 215 A tubes used in this set are very rugged and quite good 5-meter oscillators. (The English midget tubes would no doubt be just as good, and much more economical on filament batteries, but they were not available when the set was tried out.)

In conclusion, do not try to put the transmitter on the air with an antenna, since it is rated as a transmitter just as its higher-powered brothers, and such operation is illegal unless the owner has a regular license from the Federal Communications Commission.

LIST OF PARTS

- Two Hammarlund condensers, 25 mmf., C4;
- Two I.R.C. midget resistors, 1 meg., R1, R2;
- Two Solar m.ca condensers, 200 mmf., C5;
- Three Sprague midget paper condensers, .01-mf., C2, C7, C8;
- One Sprague midget paper condenser, .015-mf., C6;
- Two toggle switches, Sw.;
- One Aalloy Transformer Co. midget 200-ohm-to-grid "mike" transformer, T1;
- One interruption-frequency coil, T2 (see text);
- Four phone-tip jacks—"Mike" and "Phones";
- Two type 215 A tubes, with sockets, V1, V2;
- Wire, case material, knobs, etc.

MAKING A 12-TUBE HIGH-FIDELITY BROADCAST RECEIVER

(Continued from page 534)

LIST OF PARTS

- *One special power transformer, T1;
- *Two special shielded A.F. chokes, 10 hy., 150 ma., 160 ohms each, Ch.1, Ch.2;
- One unshielded choke, 300 hy., 2 ma., Ch.3;
- Two Cornell-Dubilier paper condensers, 10 mf., 150 V. (working), C3, C4;
- One Cornell-Dubilier paper condenser, 8 mf., 500 V. (working), C2;
- One Cornell-Dubilier oil-impregnated paper condenser, 4 mf., 600 V., C1;
- *One chassis;
- One RCA or Raytheon type 83 tube, V1;
- One RCA or Raytheon type 45 tube, V2;
- Two Eby 4-prong wafer sockets, V1, V2;
- One Eby 5-prong wafer socket;
- One 1.5A. fuse and fuse mount, F.
- *Names of manufacturers will be sent upon request.

This NEW Type of RADIO TRAINING

ACTUALLY SETS YOU UP IN BUSINESS...

... In the Fastest Moving Industry in the World ...

Here, at last, is a NEW and DIFFERENT type of Training that not only teaches you all phases of Radio Service Engineering work—but which equips you for an actual start in business. No matter what kind of Radio training you may take, you will require such materials before you actually are ready for business. Sprayberry Training gives them to you—teaches you to work with them under actual Service conditions.

Nor is that all. Never forget that there are too many men of only mediocre

ability in ALL lines of business. That is why average wages are low—why many men are out of work. Radio is no exception. But there is always room—there is good pay AT THE TOP OF THE LADDER—and this is where Sprayberry Training is specifically designed to put you. It is for men who take Radio seriously—for those willing to work along sound, intensely practical lines to win a real future in a fascinating industry with vast opportunities for future development.

NO PREVIOUS EXPERIENCE REQUIRED —LEARN AT HOME IN SPARE TIME

Sprayberry Training is really two courses in one. Besides the necessary fundamental teaching it includes the famous Sprayberry Practical Mechanics of Radio Service formerly sold ONLY to men already in Radio—many of whom had found their previous training inadequate for modern Radio needs.

Sprayberry Training has been honestly, conscientiously developed to fit you for a truly worthwhile place in Radio—a place well above the average. It is different from any other course you might consider. It is complete—modern—practical.

This Complete SERVICE ENGINEERING EQUIPMENT Is Yours!

Upon completion, you have both the knowledge and equipment to enter business then and there for full or part time profits—or to start out in any one of Radio's specialized fields such as sound, broadcasting, etc. Certainly you owe it to your future to investigate—TODAY!

SPRAYBERRY ACADEMY OF RADIO

2548 University Pl., N.W., WASHINGTON, D.C.

Without cost or obligation on my part please rush complete details of your new type of training and the booklet "MY FUTURE IN RADIO." (Paste this coupon on postcard and mail today!)

Name..... Age

Address..... RC 3/36

BEFORE ENROLLING FOR ANY HOME STUDY COURSE, YOU OWE IT TO YOUR FUTURE TO INVESTIGATE THIS ONE.

BE SURE TO READ THE ANNOUNCEMENT ON PAGE 570 OF THIS ISSUE WHICH TELLS ABOUT THE NEW BOOK—A B C OF AIR CONDITIONING

STENTORIAN SOUND AMPLIFIER NUCLEUS

REMEMBER! —Build your Amplifiers STENTORIAN way—for powerful clear volume at low cost. For stadiums, call systems, lodges, banquets, advertising, etc.



NUCLEUS includes "Pull-Push" transformer, chokes, audios, outputs and lettered chassis, 6-10-15-30 watt amplifiers, A, AB power, 2.5, 6.3 v. tubes. Also for mike Pre-Amplifiers; and battery amplifier.

FREE!—Send for full details and illus. bulletin—STENTORIAN Amplifier Nucleus and name of your distributor.

General Transformer Corp.
504 S. Throop St., Chicago

Manufacturers of Replacement Units.

Please Say That You Saw It in RADIO-CRAFT



The 31 Essentials
of MODERN RADIO SERVICING
all in one 1300-page book

1. Measuring Instruments
2. Resistance Measurement
3. Constructing Ohmmeters
4. Commercial Ohmmeters
5. Capacity and Condenser Testers
6. Output and V-T Voltmeters
7. Tube Checkers
8. Constructing Tube Checkers
9. Commercial Tube Checkers
10. Voltage-Current Set Analyzers
11. Point-to-Point Testing
12. Constructing Set Analyzers
13. Commercial Set Analyzers
14. Service Test Oscillators
15. Constructing Test Oscillators
16. Commercial Test Oscillators
17. Preliminary Trouble Tests
18. AVC and QAVC Circuits
19. Voltage-Current Receiver Analysis
20. Resistance Method of Analysis
21. Tests for Individual Components
22. Difficult, Obscure Troubles
23. Aligning and Neutralizing T-R-F Receivers
24. Aligning Superheterodynes (Cathode-Ray)
25. Repair of Individual Parts
26. Auto-Radio Installation and Servicing
27. All-Wave Receiver Servicing
28. Marine Receiver Installation and Servicing
29. Electrical Interference Reduction
30. High-Fidelity Receiver Problems
31. How to Sell Your Service

Ghirardi's MODERN RADIO SERVICING
\$5.00 with 240-page Radio Field Service Data book
RADIO & TECHNICAL PUBLISHING CO.,
45 Astor Pl., New York Dept. RC-36

Send for FREE LITERATURE

With Leads or With Lugs . . . ELECTROLYTICS



Those sturdy metal-can Aerovox electrolytics, inverted mounting, are offered with leads or with lugs.

The GL series is provided with convenient flexible polarity-indicating leads. In single and double sections, with individual sets of leads.

The G series has lug terminals. In grounded negative and insulated negative designs. In single, double and triple sections.

Also other series covering universal mounting, strap mounting, screw-stud mounting, etc.

DATA New 1936 Catalog covers greatest assortment of condensers and resistors. Send for copy, together with sample of monthly Research Worker.

AEROVOX CORPORATION
77 Washington St. : : Brooklyn, N. Y.

HOW TO MAKE A "FREE-REFERENCE-POINT" RESISTANCE-CAPACITY ANALYZER

(Continued from page 528)

"TEST" jacks for a series connection.

To use the high range, set Sw.1 to "AC," Sw.2 off, Sw.3 to "OHMS" Sw.4 to "R," and Sw.5 to the spare post. With the transformer used by the writer, a total of 400 V. is obtained for the ohmmeter. Greater or less voltage may be obtained from other transformers, and it is advisable to calibrate this range after the unit is assembled. Ohm's law is used for the calibration. Tests are made with the leads in the "TEST" jacks.

BRIDGE MEASUREMENTS

Set Sw.1 to "A.C.," Sw.2 to off, Sw.3 to "OHMS," Sw.4 to "R," and Sw.5 to the approximate value of the unknown resistor. The bridge knob is rotated for least hum, at which point the value of the resistor is indicated. Resistance measurements as low as 0.1-ohm and as high as 50 megohms are possible with the bridge circuit!

SOCKET ANALYSES

The requisite cable by means of an adapter, is plugged into the set socket. The test leads, plugged into the "TEST" jacks, are used to contact the individual pins. Measurements may now be made between any two points on the same socket, or between any two points between any two sockets. (The set of course must be disconnected from the wall socket before any tests are made.)

External Tests: These tests are made by connecting a known standard to the "EXT." jacks, and the unknown unit to the "TEST" jacks. Set Sw.5 to "EXT." and other controls according to the type of unit being checked. The outside scale on the bridge indicates the ratio.

Center-Tapped Transformer Windings: Connect the center-tap to positive and one end to negative "TEST" jacks. Connect the other end to one "EXT." jack, and proceed as above. This must be the post which connects to Sw.5. A perfect balance will be indicated on point 1. Complete to left or right, indicates open or short, either condition rendering the transformer unsuitable for use.

Transformer Ratio: Connect one winding to "EXT." and the other to "TEST." If a null point is not found, reverse the leads of one winding. The ratio is indicated on the outside scale. Knowing the voltage of a power transformer primary, all other voltages may be found, using this test.

Short-Circuits: Minimum hum at extreme right of scale is an indication of a short-circuit.

Open-Circuits: Minimum hum at the extreme left of the scale indicates an open-circuit.

LIST OF PARTS

- One Electrad 1,000-ohm variable resistor, R1;
- One Electrad 4,000-ohm variable resistor, R2;
- One Electrad 4,500-ohm wire-wound resistor, R3;
- One Continental 0.5-meg. resistor, 1/2-W., R4;
- One 1 ohm resistor (rewound from filament resistor), R5;
- One Continental 5,000 ohm resistor, R6;
- One Continental 50,000 ohm resistor, R7;
- One Continental 0.5-meg. resistor, R8;
- One Continental 5-meg. resistor, R9;
- One Electrad 0.4-meg. resistor, R10;
- One Cornell-Dubilier 8 mf. electrolytic condenser, C1;
- Two Cornell-Dubilier 0.5-mf. paper condensers, C2, C6;
- One Cornell-Dubilier 500 mmf. paper condenser, C3;
- One Cornell-Dubilier .005-mf. paper condenser, C4;
- One Cornell-Dubilier .05-mf. paper condenser, C5;
- One Cornell-Dubilier 5 mf. paper condenser, C7;
- One Eby 4-prong wafer socket;
- One Raytheon type 80 rectifier tube;
- One candelabra socket, for neon tube;
- One 1/4-W. neon glow lamp;
- Four Eby sets of tip jack;
- One General 30 hy. filter choke;
- Two Blan 1 1/4 in. pointers;
- One Blan 2 1/4 in. pointer;
- One General power transformer (6.3, 5.0, 325-325 V.);



The rear view of the tester.

- One "C" battery analyzer-type, 4 1/2 V.;
- One panel, 7 x 9 ins.;
- Two Eby octal sockets;
- Two 8-wire cables;
- Two 7-prong plugs;
- Two midjet battery clips;
- One S.P.S.T. toggle switch, Sw.1;
- Two S.P.D.T. toggle switches, Sw.2, Sw.3;
- One D.P.D.T. toggle switch, Sw.4;
- One 7-point, 3-gang tap switch, Sw.5.

I-METER SUPERHET. SERVICING PROCEDURE

(Continued from page 526)

signal is detuned; the greatest deflection towards zero indicates the station is correctly tuned.

(2, 3, 4) Tune in a station with a steady signal. Adjust I.F. transformer trimmers, the greatest deflection towards zero on the meter being the resonance point. The trimmers on the tuning condensers can then be adjusted for greatest deflection.

(5) By connecting different antennas to the set, the meter will show by the greatest deflection the antenna giving best collective results.

(6) As various stations will have a different deflection and the deflection is in direct relation to the speaker output, a volume value can be determined such as weak, poor, good, strong, very strong, etc.

(7) The meter shows at a glance whether the station tuned-in is worth listening to in relation to fading; sudden drops to maximum scale reading indicate entire absence of signal.

(8) With the set tuned-in on a fading signal and the reproducer at room volume, the meter when swinging towards maximum indicates a decreased signal input. If the volume in the speaker remains at the same level, or possibly increases slightly on a sudden swing towards maximum, the automatic volume control action is OK.

(9) By trying different coils and windings the greatest deflection will indicate the most efficient coil.

(10) As tubes and circuits will work best at certain voltages, these voltages can be adjusted to get greatest signal strength on the meter. The bias values can be treated in the same manner.

(11) Fixed condenser and resistor values can be determined as these units directly effect the signal strength and therefore the meter will indicate best values.

(12) Tube performance can be determined as the meter will show the difference between a good and poor tube.

All of the above tests with the exception of No. 8 can be made without any racket coming from the speaker, with the volume control at minimum.

THE RADIO MONTH IN REVIEW

(Continued from page 519)

Also there is little doubt that the offices of NBC and CBS will be flooded with caustic comments by listeners because bewhiskered musical selections are heard in place of newer favorites!

STEEL RIBBON RECORDING IN FRANCE

A NEW scheme for broadcasting spot news programs has just been successfully tried by the French P.T.T. station in Paris, according to a report received last month.

The old system of magnetic recording on steel wire or tape which has been gaining some favor in Europe is now being used to record these spot news items, which later on in the day are put on the air at scheduled hours.

Please Say That You Saw It in RADIO-CRAFT

CORNERSTONES OF RADIO —OHM'S LAW

(Continued from page 527)

tion more agreeable and readily understandable, and after all who likes to talk about something which nobody has seen or will, perhaps, ever see?

Let us take for granted that this magnifying glass has a magnification power sufficient to enlarge a single electron so as to obtain dimensions as large as an average person, and since people are something familiar to us let's forget that we spoke about electricity, electrons, etc.

A RIDE ON THE NEW YORK SUBWAY

As we know, the best location to observe humankind is in crowded places. We shall, therefore, make a trip on a New York subway during the rush hour, because there is hardly another place in this world quite as crowded as this subway. The New York readers know this from experience, and others no doubt have heard about it.

We pay our nickel and enter the broad platform. There are a great many people waiting for the arrival of the next train, and if we make ourselves believe that no one on this platform moves, we may compare the platform with a storage battery. Not a storage battery for electricity, because we promised to forget about electricity, but a storage battery for humans.

We wait a short time for a train to arrive. But when it arrives we perceive that nobody leaves the train, and that it is obviously packed to full capacity. Despite the fact that agile New Yorkers cannot compete with the swift electrons which are able to develop a speed of 186,000 miles per second, they are mighty fast in trying to press themselves into the already packed cars. At doors where only a few people try to enter the car, they may enter without much pressure, but at doors where a great many newcomers are eager to penetrate the thick mass of passengers already in the car—the newcomers find a considerable resistance, and only by force are they able to get in. In some cases even this does not help and the more or less friendly platform guards must push them with all their might into the car.

About the same situation occurs when electrons (of which electricity actually consists) try to flow from a storage battery (platform of the subway) into a resistor (a crowded car). If the value of the resistor is very high (if the car is very crowded) and only one battery is applied, the electrical pressure (or electrical tension) will not be high enough to press all the desired electricity through the resistor. The platform guards of the New York subway solve the problem by pushing the people with all their might into the car. Engineers do about the same trick by increasing the electrical pressure (increasing the voltage) which affects the electrons in the same way as the pushing power of the subway guards. See Fig. 1.

A SHORT WAY TO EXPLAIN A LONG STORY

The example of the subway compared with the description of what engineers do to overcome the resistance of an electrical resistor has shown us very clearly that regardless of whether human beings or electrons are involved a large resistance can only be overcome by heavier pressure. If we desire to write down this experience in a very short form we could write it in the following way. The more the people that are waiting on the platform, and the more crowded the car is, the more pressure is necessary to cram the newcomers into the car; or if we speak in electrical terms: The higher the resistance through which we wish to send a current the more electrical pressure (the more tension or "volts") must be applied. But even this description is still quite clumsy, and by compressing our experience into a much simpler form we come to the formula: (See also Fig. 2.) Outside pressure necessary = Resistance of people in the car \times Number of people who wish to enter the car.

Since voltage is internationally expressed in volts (abbreviation for volts = E), and the unit of electrical resistance is the ohm (abbreviation for ohm = R), there remains only to explain the unit of electron flow. The accepted

way to do this is in terms of a current, as electrons themselves are too tiny to be practical for this purpose. In quite the same way we do not speak of the drops of water which flow through a pipe but speak rather of the flowing water current. The unit of electrical current is the ampere (abbreviation for ampere = I).

After we discuss these details there remains only the fact that the essential rule governing Ohm's Law is founded upon the experience that when we have 1 volt available, we are able to send through an electrical circuit having the resistance of 1 ohm, an electrical current of 1 ampere.

Since this is a clumsy way of writing the essence of Ohm's Law, another method of doing it has been devised, and today all over the world Ohm's Law is written as shown in Fig. 3.

If we enlarge the resistance to 5 ohms, the formula tells us that we need 5 volts to conquer the electrical resistance. If the resistance remains constant at 1 ohm but we want to send through the resistor a current amounting to 6 amperes the formula tells us that the voltage necessary is 6 volts, and so on.

HOW TO DETERMINE THE VALUE OF A CURRENT

The formula given by Fig. 3A enables us only to figure the necessary voltage to be applied if we know the resistance and the current to reckon with. However, if we want to find out how many amperes will go through a particular resistor when a certain voltage is applied this formula will not do the trick, and Ohm's Law appears to be of restricted value. The same impression existed some 50 years ago, but "Mr. Ohm" dispelled it by providing us with the formula shown in Fig. 3B.

At first this formula appears forbidding because of its mathematical makeup. But since we know that "I" means current in amperes, "E" means electrical tension in volts, and "R" means electrical resistance in ohms, we shall try to use this formula.

Let us take a case where we have a voltage of 10 volts available, and the resistance of the circuit is 5 ohms. How many amperes will flow through the resistor? The answer is quite simple:

$$10 \div 5 = 2$$

and we know a current of 2 amperes will flow.

However, some readers will say: "That is all right, but what can we do when we know only the voltage applied in a circuit and the current which flows through it but we do not know the value of the resistance?" This trouble occurred also long before we were born, and our good "Mr. Ohm" again came to the rescue, designing for our benefit the formula in Fig. 3C.

Now, if we have a voltage of 10 volts and a current of 2 amperes flows through the resistor, how great is the resistance of "R"? The solution of this problem is quite simple, since $10 \div 2 = 5$ we know that there is a resistance of 5 ohms in the circuit.

These formulas are of immeasurable value to any amateur and Service Man who wishes to know more about radio receiver design and construction than the man who constructs his set in cook book manner. And it does not matter how many ohms, volts or amperes are applied in a circuit, the formula will always help us to find their exact value when direct current is the medium with which we are dealing.

Fig. 3. The three forms of Ohm's Law.

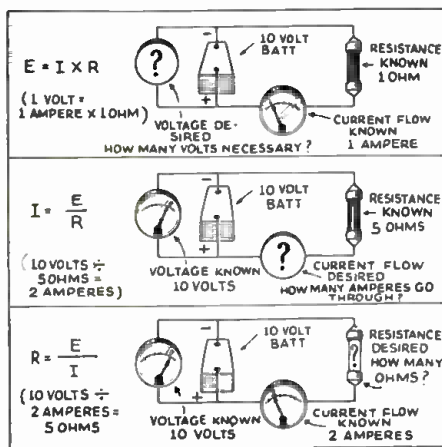

Please Say That You Saw It in RADIO-CRAFT

"I'M SURE SOLD ON THIS NEW SYLVANIA BOOK"



SEND FOR YOUR
FREE COPY OF
SERVICE HINTS
TODAY. IT MAKES THE
TOUGH JOBS EASY

● Service men all over the country tell us they wouldn't be without this new volume of Sylvania Service Hints. It helps them out of lots of tough spots, because it was actually written with their problems in mind!

Successful service men . . . men who know radio and are on the job every day . . . wrote this book. They sent in their solutions to hard-to-crack problems . . . and Sylvania just compiled these solutions into "Service Hints," Volume 2.

In this new book you'll find answers to questions that may have been bothering you . . . hundreds of short cuts that practical service men have discovered for themselves . . . up-to-date tips on circuit and receiver troubles.

Don't wait. Mail the coupon below for your copy of Sylvania SERVICE HINTS today. This up-to-the-minute information may put you in line for jobs you didn't know you could do! Clip the coupon now . . . you'll receive your copy of SERVICE HINTS in a few days.

Hygrade Sylvania Corporation.
Makers of Sylvania Radio Tubes and Hygrade Lamps. Factories at Emporium, Pa., Salem, Mass., and St. Mary's, Pa.

SYLVANIA

THE SET-TESTED RADIO TUBE
© 1936 Hygrade Sylvania Corp.

Hygrade Sylvania Corporation
Emporium, Pa. RC-3

Please send me free, without obligation, Volume 2 of Sylvania's "Service Hints."

Experimenter Amateur Call
Service man Employed by dealer
Independent

Member Service Organization

NAME

ADDRESS

CITY STATE

NAME OF JOBBER

ADDRESS

FREE CATALOG



FEATURING PUBLIC ADDRESS!

Let Lafayette engineers tell you how to get into this lucrative field this summer. The season of conventions, athletic and outdoor social events is at hand. All need Lafayette Public Address. Our proven, business-getting plans are used by radio service men everywhere. Consultation without obligation is invited. FREE Catalog describing complete line of Equipments and accessories on request.

Address Dept. C-36

WHOLESALE RADIO SERVICE CO.
NEW YORK, N.Y.
100 SIXTH AVE.

CHICAGO, ILL. 401 W. JACKSON BLVD.
ATLANTA, GA. 430 W. PEACHTREE ST. NW
BRONX, N.Y. 942 E. FORDHAM RD.
NEWARK, N.J. 319 CENTRAL AVE.

Yes the IMPOSSIBLE is a REALITY—the Amazing WRIGHT-DECOSTER **NOKOIL** DYNAMIC REPRODUCER



"All that the name implies"

NO FIELD COIL OR CURRENT

- Performs like an electro-dynamic reproducer
- Requires less space than an electro-dynamic speaker
- Priced to compete with electro-dynamic reproducers
- The answer to the demand for a compact permanent magnet dynamic speaker
- Available in 6" and 8" models

Write for complete catalog, prices and name of nearest distributor. Wright-DeCoster distributors are always anxious to cooperate.

WRIGHT-DE COSTER, Inc.
2251 University Ave. St. Paul, Minn.
Export Dept. M. Simons & Sons Co., New York
Cable Address "Simontrice"
Canadian office—A. M. Flechtel & Co., Guelph, Ont.

A BEGINNER'S SECTIONAL TEST PANEL

(Continued from page 530)

outfit you will need, first of all, a meter. This is, of course, the most important and expensive item on the list, and deserves careful thought. A word, then, about meters in general:

A meter is a small motor that turns only part way round against a spring with a needle and dial to show how far the power used can swing it. Its coils have a constant resistance, so, the more current in them, the more power, torque (twist), and swing . . .

$W = IE$ or I^2R when W is power in watts
 I is current in amperes
 R is resistance in ohms
 E is potential in volts

And since the current in a constant resistance depends on the voltage across it, the swing is also proportional to the volts.

$$E = IR$$

So the most sensitive meter is the one which uses the least power to swing it over, the least current in the coils, and (usually) the most turns of wire. This means that fine wire must be used, having a fairly high resistance (50 to 250 ohms) just big enough to carry the rated current (.0005-to .01 ampere) at coil potentials (0.125- to 0.5-volt) which means this tiny motor has only .000625-watt or about 0.00000009-horse power! No wonder it needs careful operation!

CALIBRATING FOR VOLTAGE

Some meters are made with an added internal resistance to total a thousand ohms with or without (compensated) rectifier for A.C. measurements, so it passes one milliamperer at one volt, and therefore is rated "1,000 ohms per volt." With such a meter you can easily read any voltage, current, or resistance in a radio circuit. At no time, however, should you have more than one milliamperer of current in the coils, or more than one volt drop across the terminals. How is it possible to read higher values, then? It's very simple. Let's take the voltage readings first.

Suppose you want to read up to 100 volts. One volt may be applied at the terminals of the actual meter but the rest (99) must be dropped off outside. One milliamperer is the current throughout, so there must be 99,000 ohms in series if IR is to equal E (99). The formula for any meter is:

$$R_x = \frac{E_t - E_m}{I_m}$$

when R_x is the external resistance in ohms
 E_t is the total volts to be read
 E_m is the full meter scale in volts

I_m is the full meter scale in amperes
For a scale of 200 volts, 199,000 ohms is added to the original 1,000, and so on. Successive resistances may include preceding links, and taps brought to a selector switch (as in Fig. 1B). These resistors must be non-inductive and well insulated as they must work at high voltage overall and sometimes at high frequency.

CALIBRATING FOR CURRENT

Calibrating for current is just as easy, but the idea behind it is a bit different. It's like a highway detour for the heavy traffic around a weak bridge. We split the current, one milliamperer through the meter, and the rest around it by a "shunt" path. For example: if you want to

read up to 10 milliamperes, the meter path can take 0.001-ampere and the shunt must carry the other 0.009-ampere. This means it must be nine times as easy to go through the shunt, or one-ninth the resistance of the meter path, which is 1,000 ohms. The shunt, then, should have 111.1 ohms. All currents less than 10 milliamperes will divide proportionately, so if the meter reads 0.3-milliamperer, a total of 3 milliamperes is in the line, and so on. The general formula:

$$R_s = \frac{IMR_m}{I_t - I_m}$$

when R_s is the resistance of the shunt in ohms
 I_m is full current for the meter in milliamperes

R_m is the terminal resistance of the meter in ohms

I_t is the maximum current to be read in milliamperes

These shunt resistors should be able to carry double the rated current without heating, as heat raises resistance, thereby letting more current go the other way. You can connect them to another selector switch (as in Fig. 1B) but be sure the contacts overlap, so that at no time will the shunt be open (except on open tap for voltmeter). Otherwise, when reading plate current, "phf-f-s-st" would go your meter!

THE ALL-PURPOSE ANALYZER CIRCUIT

The analyzer circuit (Fig. 1A) should be fairly clear from the diagram, but its various applications may not be so readily seen. The theory of testing circuits is not the province of this article, but a suggestion will point the way. With plug-in leads connect the meter unit M-M1 to an ohmmeter unit (Fig. 1C) at points 0-01. With two more leads from jacks on the resistor clip, R-R1, you can read point-to-point resistance on the analyzer strip. If you cut in a measured value, you can check for shorts between any tube elements. From the battery, R1-01, you can cut into circuit various bias voltages when reading plate current for tube curves.

The possibilities of this simple, fundamental circuit are limited only by the knowledge of the user. (See Table I).

This article has been prepared from data supplied by courtesy of M. Schwartz & Son.

NEW HINTS ON ELIMINATING INTERFERENCE

(Continued from page 535)

business can be had if you obtain the job of eliminating interference from them. Certainly it is a field well worth the time and effort required to win it.

Complaints regarding traffic light interference should be made to the local police commissioner, public works commissioner, city electrician or contractor.

Modern radio sets are becoming more and more sensitive, a condition which is making it increasingly important and profitable for the Service Man to acquaint himself with the equipment and procedure for rapid analysis and correction of interference problems.

This article has been prepared from data supplied by courtesy of Sprague Products Co.

Table I
Connections (See Fig. 1, A, B, and C)

- | Test | Connections (See Fig. 1, A, B, and C) |
|---|---|
| 1. All voltage tests (Fig. 1D) | M-M1 to J-J1, X closed |
| 2. All current tests | M-M1 to J-J1, X open |
| 3. Tube curves (EgIp). Read Ip as in 2 | R1-01 to J-J1 (grid), XX open; vary Eg on battery selector |
| 4. Tube curves (IpRp): vary Rp on rheostat | M to 0, R1 to J (plate); X open, M1 to J1 |
| 5. Point-to-point resistance (Fig. 1E) | M-M1 to 0-01, R-R1 to J-J1 |
| 6. Tube short test, cold cathode | As in 5, but all X open |
| 7. Tube short test, hot cathode | As in 6, but heater X closed |
| 8. Comparison test, resistance; read results as in 1 and 2 | 0-R1 to J-J1; clip extra resistance in R-R1 |
| 9. Comparison test, capacity; results as in 12 | 0-R1 to J-J1; clip condensers in R-R1 |
| 10. Capacity readings (meter on A.C. scale) | M1 to R1, O-M to A.C. supply, and R-R1 to condenser on test |
| 11. Electrolytics, as in 5 | Neon bulb in R-R1 |
| 12. Tube leakage, as in 11, 6 and 7 | To J (cathode) and J1 (grid), X open |
| 13. A.F. or R.F., oscillator input | To screen J and plate J, X open |
| 14. Output or oscilloscope | Connect control J to screen J1, put 0-R1 in series, and adjust for correct screen or plate volts. |
| 15. Try different type tube; if different heater volts, supply from R1-01 | |

Please Say That You Saw It in RADIO-CRAFT

A "MAGIC-EYE" LEAKAGE TESTER

(Continued from page 531)

zero adjustment to take care of wide variations in line voltage.

In addition to leakage testing, the tester can be used as an output meter in aligning receivers. This use requires that there must be at least 1. V. across the circuit to be measured. This readily suggests the adaptability to magnetic speaker circuits, particularly on midset receivers. The burden of the output meter ordinarily employed affects tone quality to such an extent that a high-quality job cannot be readily done. However, the load of this circuit is practically nil and for this reason does not affect tone quality. The "E" battery is omitted in this test. Resistor R4 should be set at zero resistance.

Another use is in the alignment of receivers with A.V.C. In this case terminal P1 of V1 is connected to the receiver A.V.C. line at a convenient point and alignment made on the same basis as with any other output meter. The grid-leak included in the tester is removed for this test. The "E" battery also is omitted. Resistor R4 should be set at zero resistance.

Many other uses will suggest themselves to the user after the recommended uses have been tried. To mention a few: A.C. filament voltmeter, hum measurement, and practically any of the uses of a vacuum-tube voltmeter with a fundamental range of 0-8V.

CONSTRUCTION

The construction of the unit will necessarily vary with the preferences of the individual constructor, but, from examination of the circuit here presented in Fig. 1 and after a thorough study of the photographs, the construction should be simple.

All of the parts used are standard. The power supply must deliver from 200 to 250 V. D.C. and may be made from any junk at hand. The resistors in the 6E5 circuits should be trustworthy but need not be precision type.

The "E" battery is composed of 10 "penlite" flashlight cells in order that the desired 1.5 V. and 15 V. can be tapped off for range change.

LIST OF PARTS

The following list is given for parts which are actually necessary for operation of the 6E5 tube. The parts for the chassis and power pack can be picked to suit the experimenter.

- One RCA Radiotron or Sylvania 6E5 Cathode-Ray tuning Indicator, V1;
- One Bud 6-prong wafer socket for V2;
- One I.R.C. 1.-meg. gridleak, R3;
- One I.R.C. 1.-meg. plate resistor, R1;
- One Electrad 50,000 ohm volume control, R4;
- Ten 1.5 V. penlight flashlight cells, E.

AN ALL-WAVE ADAPTER FOR OLD SETS

(Continued from page 533)

the addition of the P.C.A. unit properly aligned the over-all sensitivity available is better than about 1 microvolt-per-meter.

The trick of this whole story is in obtaining an all-wave tuning assembly that does not require a corps of experts to assemble, wire and align. Such an assembly, "ready to go," and requiring only a few screws for mounting and the use of a few leads for connecting into the circuit, is available.

LIST OF PARTS

- One Tobe 3-band P.C.A. tuner (the dial, escutcheon and knobs are included with this tuner);
- One United Transformer power transformer, 250 V. at 20 ma., with 6.3 V., filament winding to carry 1 A.;
- One United Transformer choke, 400 ohms, 10 to 12 hy.;
- One 6-prong socket;
- One 100 V. receptacle;
- One line cord;
- One single-pole rotary 110 V. switch;
- One Centralab 10,000-ohm volume control;
- One Tobe chassis and antenna strip;
- One Tobe condenser, .05-mf., 300 V., MSO;
- One Tobe double electrolytic condenser, 8 mf., 500 V.,
- Knobs for volume control and switch.

NEW
THE MOST IMPORTANT
RESISTOR DEVELOPMENT
IN THE HISTORY OF RADIO



INSULATED *Metallized* RESISTORS

... The **FIRST** solidly sealed **INSULATED** Resistors—designed to meet your demands for the best modern radio performance.

... No danger of shorts. No metal ends or caps. Complete, high voltage insulation molded around **FAMOUS METALLIZED TYPE RESISTANCE ELEMENT** also seals it against moisture.

... Smaller—Quieter—More accurate.

... No "opens." Wire leads permanently contacted to resistance element **inside** molded insulation.

... Rugged—Strong—Vibration-proof—Light in weight.

... Both color coded **AND** imprinted with resistance value.

INTERNATIONAL RESISTANCE CO.
401 N. Broad St. Philadelphia, Pa.
(In Canada, 187 Duchess St., Toronto, Ont.)
Prices slightly higher in Canada



(Right) IRC RESIST-O-CHEST—handiest container for resistors and other parts. Get it free with your order for 10 Insulated Resistors. Ask your jobber.

Never before has a resistance development received the widespread approval accorded IRC Type "B" INSULATED METALLIZED Resistors. . . . And never have resistors warranted greater praise. For here are truly modern units—fully sealed and insulated, compact, quiet and more accurate than ever—designed to meet the most exacting demands imposed by the finer, more sensitive radio equipment of today. These unique NEW IRC Resistors incorporate every famous Metallized advantage plus many new ones besides. Far beyond the experimental stage, they have already been used by leading manufacturers for two years. Now sold by leading jobbers. Two sizes, B-1/2 (1/2-watt) and B-1 (1-watt) meet every need. Try them and be convinced!

FREE SAMPLE

To bonafide servicemen and amateurs requesting it, we'll gladly send FREE a sample 1/2 Watt unit (List value 20c). See for yourself how good they are. Write today for catalog S-88 and sample resistor.

To Readers of RADIO-CRAFT
FREE POST CARDS MAY BE HAD UPON WRITING TO PUBLISHERS

These postcards make it easy to answer advertisements which appear in RADIO-CRAFT, without cutting valuable data which you may wish to save. Many times manufacturers request you to "clip the coupon" when answering their ads. Often this means destroying part of an article on the reverse page you may need later for reference. Save your RADIO-CRAFT issues complete. If you should ever want to see bound volumes, or certain copies of RADIO-CRAFT, the resale value of uncut issues is very much higher than that of mutilated ones. So send for a supply of these free post cards and use them in answering all RADIO-CRAFT advertisers.

AT LAST! A Perfect CODE TEACHER!
The NEW Master Teleplex
The Perfect Instrument

for beginners, experienced operators, and schoolroom. The new easy way to learn code and speed up wpm. This amazing new instrument will record your own sending on double row perforated paper and repeat it back to you at any speed. 10,000 words can be recorded on one tape.

This New Machine is Remarkable
No Batteries No Winding All Electric
It is the same in principle, and in operation is equal to the Wheatstone Perforator and Transmitter, which would cost over \$1,000.

Buy it or Rent it
Send for Folder A3, which tells you how to get the use of this instrument without buying it. No obligation. We furnish complete course and personal instruction. Low cost, easy terms. Write today for information.

TELEPLEX CO.
72 Cortlandt St. New York City
The New Master Teleplex—"The Choice of Those Who Know"

Please Say That You Saw It in RADIO-CRAFT



Servicemen!

YOUR FUTURE IS WHAT YOU MAKE IT!

According to conservative estimates, one out of four servicemen fail or go out of business EVERY YEAR!

Will you be among them? Will you be one of the even larger group making only a bare living from the work . . . Or, will you join the select, ambitious few who, in every town and city, grasp existing opportunities and build an outstanding success?

Sprayberry Training is specifically designed for men who aim to be in the successful group. Through it, I want to help you forge ahead as I have already helped hundreds of others. I want to help you do all types of radio work easier and quicker—help you build a REAL future in the work to which you are devoting your life.

REMEMBER! Mine is not a "course" for beginners. It is **ADVANCED TECHNICAL AND BUSINESS TRAINING** for men who believe in making the most of their opportunities in servicing. No "fluff," fancy bindings or useless theory. From beginning to end, you get sound **PRACTICAL HELP**—at a fraction of the cost you might expect to pay. Investigate!

F. L. SPRAYBERRY, 2548 University Pl., N. W., Washington, D. C.

Without cost or obligation, please send your book "PUTTING PROFITS AND EFFICIENCY INTO SERVICING."

Name

Street

Address RC 3/36

SPRAYBERRY'S PRACTICAL MECHANICS OF RADIO SERVICE



FREE

IMPORTANT ILLUSTRATED BUYING GUIDE FOR RADIO EXPERIMENTERS, SERVICE MEN, AND SHORT-WAVE FANS—32 Pages—Two Colors—Profusely Illustrated This Book Will Save You Money!

Packed between the covers of this 32-page book is a tremendous array of modern radio equipment and other electrical and scientific merchandise—the very material for which you have been looking—and at prices which cannot possibly be any lower.

Radio sets and parts, low priced microphones, automobile radio sets, complete public address equipment, field glasses, the finest short-wave equipment available, crystal receivers, radio replacement parts, etc., etc. Name the item and it's in the book! This amazing book will show you how to save money. You save by buying at the lowest possible prices. Why not start saving now? Don't delay! Write today! Send postcard or letter, book by return mail. It's free!

RADIO TRADING COMPANY

97 Hudson Street, New York, N. Y.



Universal Power Transformer

In Alloy Hum Proof Casting 425-350-0-350-425 V. at 125 m.a. 5V3A., 6V6A. C.T., and EL Shield. Type ALPFA. Net price, \$1.50. 30-13 000 cycles ± 1 D.B. Multiple Coil, Hum Free Balanced construction. **AUDIO TRANSFORMERS** in Hum Free Castings. Each net. \$3.75. **CHOKE** in Alloy Hum Free Castings, \$1.75.

ALLOY TRANSFORMER CO., Inc., 135R Liberty St., New York City

NOISE-REDUCING TWINS

LYNCH HI-FI ASSEMBLED ALL-WAVE ANTENNA

All ready to hang. Saves 90% of installation time. Amazing results. **\$6.75** List

If your dealer cannot supply you, order direct, or write for folder.

LYNCH FILTERADIO

Cuts out objectionable noise from the light line. Cannot possibly stall, simple to adjust. **\$5.00** List

Arthur H. Lynch, Inc., 227 Fulton St., N. Y. PIONEER OF NOISE-REDUCING AERIALS

THE LISTENING POST FOR ALL-WAVE DX-ERS

(Continued from page 532)

may almost always be heard in the background of WTAM, Cleveland in the early evenings, and sometimes growing so loud that WTAM is momentarily blotted out. This is none other than LRI, Radio El Mundo, pounding through our local barrage after making a trip of 6,000 miles.

An international, as well as a South American audience has been provided for at LRI, as, early in January of 1936, a powerful 7½ kw. short-wave relay started regular, scheduled transmissions of LRI's programs.

The short-wave transmitter of LRI will broadcast on 9.58 mc. under the call of LRX, and on 15.29 mc. under the provisional call LRU.

These short-wave transmissions will bring the very best of Argentinian entertainment into our homes. They are of special significance inasmuch as they will be the first regularly scheduled short-wave broadcast transmissions from Argentina, home of Latin American culture.

BROADCAST-BAND NEWS

The new station Marseilles PTT, Marseilles, France, 749 kc. has completed its tests and is broadcasting regularly with 100 kw. power.

Lyons (La-Doua) France, 648 kc., is now using 90 kw.

The mystery French station that has been heard testing on 1,185 kc. by many broadcast DX-ers is Radio Nice, (La Brague) France, and is using 60 kw. The "Dance of the Cuckoos" is used as a sign-off piece.

Pacific-Coast DX-ers should be watching for VPJ, the new 20 kw. station just completed at Delhi, India, which will operate on 822 kc.

Two new Japanese stations have been put on the air this season, namely, JOHG, Kakoshima, on 1,050 kc. with 500 W.—and JOIG at Toyama, on 1,060 kc., with 500 W. (Both of these stations have been reported in California.—Editor)

Any DX-er lucky enough to catch the new station at Jerusalem, Palestine, would have something to crow about. This 20-kw. station operates on 668 kc., and only recently took the air.

Regional Stations, 4QN, Clevedon, Q'sld., Australia, on 600 kc., 10 kw., and 2NR, Lawrence, N.S.W., 700 kc., 7 kw. should both be on the air shortly, and may even be testing by the time this article appears in print. 4YA, Dunedin, New Zealand, came on the air late on November, 1935, on 790 kc., with 10 kw., and has been putting a fine signal into the United States.

A station of unusual interest to broadcast-band DX-ers should be the one now broadcasting in Noumea, New Caledonia. This station is the mysterious French station that New Zealand DX-ers have been hearing on 600 kc. According to the British consul there, this was formerly a "code" station that has been converted for broadcast use. Tests are carried out Thursdays, and Saturdays from 2:30-3:30 a.m. E.S.T. (Who will be the first U.S.A. DX-er to log Radio Noumea on the Broadcast Band?—Editor)

Foreign Lands Corp. of Honolulu, Hawaii, has applied to the Federal Communications Commission for permission to erect a station on 600 kc., with 1 kw. of power.

OBSERVER IN NEW ZEALAND

"It has come to my notice that you are appointing Listening Post DX Observers in various parts of the world. I would represent your DX Page in *Radio-Craft* with the greatest of pleasure. I am a member of the World Radio Research League, the New Zealand DX Club, and DX Corresponding Secretary for station 4ZP, at Invercargill, New Zealand. We would be glad to arrange a special program from this station for the readers of *Radio-Craft*."

We are taking advantage of his offer, and will give you further details in an early issue of *Radio-Craft*. This letter is signed by Alex Chambers. He sends a very interesting QSL card from station 4ZP which is the most southerly-located broadcasting station in the world. It broadcasts on 620 kc., with a power of only 500 W., but has been reported in the United States several times. The QSL card is appropriately pictured with penguins, and sea lions which are listening to 4ZP. We will be glad to include reports from our new corres-

pondent, Alex Chambers, in future issues of the All-Wave Listening Post. We are interested in having Official *Radio-Craft* foreign correspondents in every country, and will be glad to receive applications for these appointments.

GERMANY PREPARES FOR OLYMPICS

Germany is making elaborate plans for broadcasting the 1936 "Olympic Games" to the world. New and improved short-wave stations at Zeesen, will probably give Germany the most advanced short-wave transmitting facilities in the world. Several of these new frequencies are already in use, and are coming through with great volume. The new German short-wave stations will have a power of 50 kw. each. Station DJI, Zeesen, may be heard daily from 5:00-7:00 p.m. E.S.T. relaying DJA on an approximate frequency of 9.65 mc. Another station, DJJ, Zeesen, may be heard testing on an experimental basis from 2:00-4:00 p.m. E.S.T. on 10.042 mc. DJM, Zeesen, 6.08 mc. is being heard in the evenings but rather weakly at present. Other frequencies that may be used include DJO, 11.79 mc.; DJR, 15.3 mc., and DJP, 11.86 mc.

SHORT-WAVE NEWS-NOTES

The special NBC transmitter which is to make a trip on the "China Clipper" during one of its trans-Pacific flights and furnish a running account of the trip to the American networks will go under the call letters WOEH, will have a power of 100 W., and will be crystal controlled. The frequencies to be used will be 2.76, 4.797, 6.425, 8.655, and 12.862 mc. The permanent radio equipment in the China Clipper is for code or C.W. only, so this may be the only chance DX-ers will have of hearing this thrilling radio voice from the middle of the Pacific ocean.

According to Vigo Smith, of Oakland, California, the old favorite HJN, Radiodifusora Nacional at Bogota, Columbia is on the air again on a frequency of 5.95 mc., and is being heard daily until about 10:30 p.m. E.S.T.

Station ZBW, of Hong Kong, China, has now changed to its winter schedule of 5.4 mc. ZBW is sometimes heard from 3:00 to 7:00 a.m., and sometimes from 6:00-9:00 a.m. E.S.T.

From *Tune In* publication of the N. Z. Radio Association we glean that "Radio Oceanic," at Papeete, Tahiti is broadcasting programs of recordings, and native music on 7.1 mc., Tuesdays and Fridays from 11:30 p.m. to 12:30 a.m. E.S.T.

Still another country is on the air, and this time the remote country of New Caledonia. H. N. Walker reports that a station which sounds like FZJB is broadcasting every Saturday night from 5:00-6:00 p.m. E.S.T. at the high-frequency end of the 20-meter amateur band from Noumea. This station announces as "Radio Noumea," and puts on musical programs, and talks on the attractions of New Caledonia as a tourist resort.

Although to this date no one has deciphered the exact call letters of the Javanese station that transmits daily on 9.58 mc., it can be definitely stated however that this is a Government station at Bandoeng, Java and relays the N.I.R.O.M. network programs, with a power of 3 kw. This station heterodynes VK3LR some mornings.

Station YV12RM, at Maracay, Venezuela, has taken the air recently on a frequency of 6.31 mc. The address is Avenida Bolivar Num. 125, and is owned by Sr. Jose R. Gomez. YV12RM may be heard transmitting irregularly from 8:30-10:30 p.m.

Another new Venezuelan station will have taken the air by the time this article reaches you, namely, "Ondas del Tacarigua," station YV13RV. This station which is being built by Senor Miguel Angel Arraez will work on 6.33 mc., and will relay a new broadcasting station on 1.155 kc. YV13RV is located at Valencia, Venezuela.

A real DX goal is CR7AA, Laurence Marques, Mozambique, Portuguese East Africa, now broadcasting on 6.135 mc. CR7AA has been testing irregularly on this new frequency but seems to have definitely settled down at present to a daily schedule of Noon to 3:30 p.m. E.S.T. (CR7AA has positively been identified in the U.S.A. on this new frequency.—Editor)

Vatican City, HVJ, 15.12 mc., is now broadcasting two schedules on Saturdays from 10:10-15 a.m., and 10:30-10:45 a.m. E.S.T.

If you have never logged RV15, in Khabarovsk, U.S.S.R., now is your chance, for this elusive station on 4.25 mc. is coming in better than ever before and may be heard as early as 1:00 a.m.,

Please Say That You Saw It in RADIO-CRAFT

and as late as 9:00 a.m. E.S.T. It is rumored that RV15 will not verify correct reports, but we can not definitely substantiate this statement.

One of the most interesting periods of the whole week is the short English program broadcast weekly by TFJ, of Reykjavik, Iceland, 12.235 mc., Sundays from 1:40-2:00 p.m. E.S.T. (This is a real DX catch to go after.—*Editor*)

The Nicaraguan station that caused so much discussion as to its actual call letters has been definitely identified as YNVA. The station is owned by Victorino, Arguello, of Managua, and broadcasts on 8.60 mc. from 7:00-10:00 p.m. E.S.T.

The Monday, and Thursday programs from the Japanese Empire which take place at 4:00-5:00 p.m. E.S.T. are now being broadcast by JVN, Nazaki, 10.66 mc., and JVP, Nazaki, 7.51 mc. These programs consist of opening announcements in English, native, and Western music, and closing with call and news in English, and playing of the National Anthem.

The Budapest stations are now coming in fine on Sunday mornings, and seem to have extended their schedules.

RADIO-CRAFT'S INFORMATION BUREAU

(Continued from page 536)

rather sensitive milliammeter with a shunt across the terminals to increase the current rating. In this case the shunt may be removed, and the meter used directly; somewhat less current than would be required for full-scale deflection.

"MULTI-TUBE ADAPTER"

(A Correction)

(361) Joe D. Lester, Berwyn, Md.

(Q.) In Fig. 1E on page 16, July, 1935, issue of *Radio-Craft*, it appears that the circuit does not correspond with that of Fig. 1F. Can you tell me which is correct?

(A.) We have received a correction on this from Mr. Vogel, the author. There is no connection between G3 and G2. Therefore, the connections shown in Fig. 1F of the original article are correct.

GENERATOR RIPPLE

(Continued from page 536)

has the lowest amount of motor-generator noise pick-up.

PUSH-PULL WINDINGS

(32) E. B. Liebe, Pleasant Valley, New York.

(Q.) How can I determine whether the split windings of an interstage transformer that I have are in push-pull?

(A.) A simple way is to impress an A.C. voltage on the primary winding and measure this winding across the two split windings joined together as shown in Figs. Q31B and C. If these two split windings are not in push-pull (out of phase) then no voltage will be developed across the secondary. If no A.C. voltage is available, touch the primary to a "C" battery and hold your fingers across the outside wires of the secondary windings. A sharp voltage surge will be felt if the secondary windings are in push-pull (in phase).

POWER OUTPUT

(33) A. K. Burns, Melville, Sask.

(Q.) I built amplifiers with type 45 tubes in parallel in the output stage and obtained excellent results, but when I tried to use four 45s, four tubes did not deliver twice as much power as two tubes. Can you explain the reason for the above?

(A.) The type 45 tube has a relatively small amplification factor and the various tubes are fairly uniform in that respect. The 45 tube, however, has a much higher amplification factor and, therefore, the difference between the various tubes is considerably larger. Thus, when these tubes are operated in parallel, part of the output voltage of one tube is fed back into another one and the total power output is thereby reduced. If two separate output transformers are used instead, the full power output of both tubes will be realized.

MAKING A GOOD CRYSTAL SET FOR 65c

(Continued from page 526)

still operating.

Stations KTAR and KOY can be separated very nicely with no interference from each other, with KTAR located about 7 blocks away and KOY about 15 blocks away.

HIGHER FIDELITY FOR EVERYONE

(Continued from page 533)

a type 27 power detector feeding 45s through a transformer. Changing the detector to a diode and adding this amplifier will give the same output with high fidelity. These circuits are also suitable for the 6.3 V. tubes. The 6A6 is the 6.3 V. equivalent of the 53; and the 42, with screen-grid tied to plate, is equivalent to the 45.

OPERATION

Care should be taken not to overload the power transformer when another tube is added to give push-pull operation. If the receiver to be modified is more than a few years old, a new output transformer to match the 45s will make a great difference. If, due to the improved low-note response, cabinet rattles appear the cabinet may be lined with celotex. The speaker itself may be mounted on celotex. This improved low-note response may show up the insufficient filtering.

In this case add an extra 8 mf. electrolytic condenser on the output section of the power supply. To cure induction hum add a shield over the 53. This amplifier is ample for all home radio sets requiring less than 5 W. output. For greater output requirements the use of a separate high-fidelity amplifier of commercial design is advised. Replacement of the speaker with one having a larger cone will improve the low notes; and if highs are wanted, tweeters or crystal speakers may be added.

Many owners of radio-phonograph combinations who appreciate good music would "go for" this change-over in a big way. The circuit may be assembled on a small chassis and attached to existing receivers by means of a small plug in order to prevent ripping up the original receiver. Be careful of long grid leads. If it is necessary to run long control-grid leads, it may be necessary to run them in shielding. (This makes it convenient to show customers the difference between the old amplifier and the new—an advantage when the customer is a critic.)

LIST OF PARTS

- Three Cornell-Dubilier 0.1-mf. 400 V. paper condensers, C1, C2, C3;
- One Cornell-Dubilier 1 mf. 400 V. paper condenser, C4;
- One Airovox 0.1 meg. 1 W. resistor, R1;
- One Airovox 1/4-meg. 1 W. resistor, R2;
- One Airovox 10,000 ohm 1 W. resistor, R3;
- One Electrad 900 ohm 10 W. wire-wound resistor, R4;
- One Airovox 3,000 ohm 1 W. resistor, R5;
- One Electrad 250 ohm 10 W. wire-wound resistor (optional), R6;
- One Electrad 2,000 ohm 1 W. resistor (optional), R7;
- One Eby large 7-prong wafer socket;
- One 24-type tube shield;
- One Radiotron or Raytheon type 53 tube;
- Two Radiotron or Raytheon type 45 tubes.

The positions of parts under the chassis of the amplifier

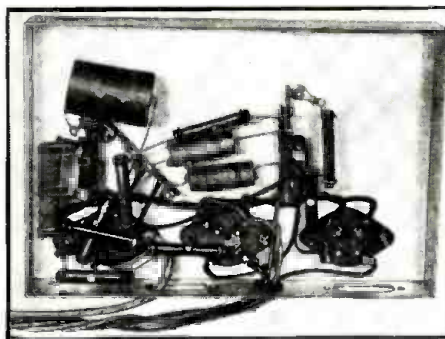

Please Say That You Saw It in RADIO-CRAFT



LOW PRICE

Precision Instruments

All-Wave Signal Generator

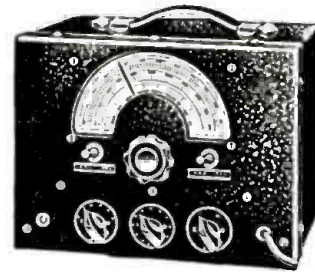

MODEL 82—net \$19.90

EVERY MODERN FEATURE: Large direct reading 8 1/2-inch dial—all-wave continuously variable from 90 kc to 20 Mc—long life self-contained batteries—new type "Band-Spread" tuning with 6 separate inductors—triple shielding—ladder-type constant impedance attenuator—modulated, unmodulated, and 400-cycle audio outputs—employs 2 type '30 tubes in separate audio and radio frequency generating circuits. Write for full description of this and the 2 other C-B r-f signal generators.

Point-to-Point Analyzer



MODEL 85 UNIMETER \$24.95

A low cost set analyzer and all-purpose component tester with a big, easy-to-read 5-inch fan-type meter. Ranges: 0-15-150-750 v d.c. and a.c.; 0-1.5-15-150 ma d.c., and ohms scales 0-100, 0-20,000, and 0-2 meg. Low ohms range is new shunt type with maximum battery drain only 2.5 ma. Hand calibrated in the C-B Standardization Laboratory. Write for new bulletin.

See This Modern Equipment at your CLOUGH-BRENGLE Jobber

- MODEL CRA Cathode-Ray Oscilloscope, net.....\$84.50
- MODEL OM Frequency Modulated R-f Signal Generator (built-in r-f sweep unit), net..... 57.75
- MODEL 79 Beat-Note Audio Oscillator, net..... 51.90
- MODEL OC Precision R-f Signal Generator, net..... 32.90
- MODEL UC Vacuum-Tube Voltmeter, net..... 34.85
- MODEL UD Power Level Indicator, net..... 24.60

Complete description of the full C-B line may be secured from your jobber, or write the factory.

Write Today for Complete Literature

Enclose 25c if a copy of "Cathode-Ray Service Manual" is desired.

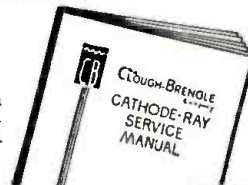

The CLOUGH-BRENGLE CO.

1130 W. Austin Ave., Chicago, U.S.A.

Send complete literature on the new C-B Line for 1936.

Name

Address

My Jobber is.....

Complete mechanism of the control, showing straight-path travel of contact shoe on resistance element.



NO WASTE MOTION in this ELECTRAD

DIRECT CONTACT

CARBON VOLUME CONTROL

The fewer the moving parts, the less chance for trouble! This new Electrad design has but ONE moving unit. The special alloy floating contact shoe glides over the carbon resistance element in a straight path, insuring uniform pressure at all points; smoother, quieter operation; more positive, finer variation of current regulation. Self-cleaning—polishes the carbon to glassy smoothness—keeps it dust free. No skipping, leaping or stuttering.

Each Electrad Volume Control is tested for noise at the factory and is *unqualifiedly guaranteed*. Use an Electrad on your next service job. Write Dept. RC-3 for 1936 catalog.



RESISTOR SPECIALISTS

Featuring:—Quiet Carbon Volume Controls, Vitreous Resistors, Truvalt Resistors and Power Rheostats.

METAL TUBES

Have Not Made Obsolete

THE SHALLCROSS UNIVERSAL TESTER

Liberal allowance made on your obsolete meters and instruments.

RANGES:



Volts A.C.—D.C.
5.25-100-250-1000
1000 ohms per volt

Milliamperes D.C.
1-10-100-1000

Capacity
.001-10 Mfd.
Paper or electrolytic
condensers.

Inductance
1-10,000 Henrys

D.C. Resistance
.5-5,000,000 ohms.

Send full description of old instrument you wish to trade-in and 6c in stamps for Bulletin 611-PD describing the Shallcross Universal Tester.

SHALLCROSS MFG. COMPANY

Electrical Measuring Instruments
and Accurate Resistors

700 MAC DADD BOULEVARD
COLLINGDALE, PA.

SOUND RECORDING ON MAGNETIC MATERIALS

(Continued from page 537)

page 388-403). As Fig. 1E, which is taken from the above-mentioned reports, shows, the frequency-response curve of the steel recording method depends to a large extent on the speed at which the wire passes the recording magnet.

As Fig. 1E indicates, only the frequencies between 50 and 2,000 cycles may be reproduced if the speed of the steel wire is one meter per second (about 3.29 ft. per second), but the fluctuations in this relatively small frequency range are about 20 db. The response curve goes up to 6,000 cycles if the speed of the wire is increased to 3 meters per second (9.97 ft. per second) but the fluctuations are increasing to about 25 db. A further increase in speed brings about better reproduction of the highs without large fluctuations in the output but causes a marked decrease in the reproduction of the low frequencies.

This unfavorable characteristic is caused by fundamental qualities of the steel-wire recording process. To obtain a better understanding of the actual conditions which are the governing factors of this recording method we have to keep in mind that the iron molecules, which are the basis of the entire recording process, are tightly bound in the mass of the iron. What this fact involves will be seen from the following description. As long as a low audio frequency is to be recorded (let's take a frequency of 100 cycles, for example), the iron molecules have plenty of time (1/100-second for each cycle) to arrange themselves in such manner that, for each cycle, a corresponding image created by disarranged iron molecules is created in the wire (see Fig. 1D).

SPEED VS. MOLECULE MOVEMENTS

However, in case a higher audio frequency is to be recorded (for example one of 3,000 cycles) considerable difficulties occur. The reason for these difficulties is quite simple, since upon a small area of the wire a great many of the individual cycles which determine an audio frequency of 3,000 cycles have to be recorded. But this is not all that worries the recording engineer. If a higher wire speed is applied to enlarge the area for the recording of the single cycles of an audio frequency of 3,000 cycles (to give an example), the response curve in respect to the lower audio frequencies decreases considerably as Fig. 1E indicates! The effect of the increase of wire speed can easily be seen by a comparison of the response curve obtained at wire speeds of 3 and 10 meters per second, with the response curve obtained by a speed of only 1 meter per second.

The reason why the low audio frequencies are so badly recorded when the speed is increased is as follows: If the speed is low, the iron molecules have plenty of time to follow in their movements the large but slow pulsations of the low audio frequencies. But if the speed is increased, the iron molecules cannot make the great swing necessary to record a low-frequency impulse, since the influence of the applied magnetic field passes too fast to give the iron molecules time to make the necessary wide turns. Instead of one or two molecules moved by a single cycle of a low frequency at low speed, twice—or even three times as many—are moved.

NOISE LEVEL VS. HIGH FREQUENCIES

Another factor which lowers the value of the steel-wire recording method is the noise level which increases considerably in the region of the high frequencies (see Fig. 1F). Above 3,000 cycles, the noise level decreases, as Fig. 1F shows, but around 5,000 cycles it is still twice as high as around 300 cycles. This increasing noise level, in connection with the increase of speed necessary to obtain a recording of the higher audio frequencies, which is considerable (10 meters per second), in the case of a frequency of 5,000 cycles, restricts the application of this recording method to reproduction in the speech range.

RANGE OF "WIRE" IS ONLY 70-2,000 CYCLES!

Since a speed of 10 meters per second (about 32 ft. per second), would bring about a wire consumption amounting to 118,000 ft. per hour, the main advantage of the steel-wire recording method (long-lasting, continuous recordings) is

nullified by the length of the wire required for high-fidelity recording.

However, if only speech is to be recorded and reproduced, the speed may be considerably reduced. The British and the German broadcasting companies which use the steel recording method operate with a speed of 1.5 meters per second (4.92 ft.). The actual frequency range utilized starts at about 70 cycles and goes up to 2,000 cycles. The length of the wire necessary to obtain a continuous reproduction of one hour is about 17,000 ft., a length which is easy to store on a reel of reasonable size.

STEEL "TAPE" INSTEAD OF WIRE

Tests made with steel tape have indicated that improved mechanical and electrical operation may be obtained as compared with steel wire. The steel tape can be led through the recording and pick-up devices with much less fluctuation than is possible with steel wire. This allows a considerable improvement in reproduction quality and a decrease of the background noise level; an improvement is noticeable in the frequency range between 50 and 100 cycles, where it is usually quite strong because of "flutter" effects. These disturbing flutter effects are difficult to avoid when steel wire is used. The pronounced influence of the background noise in the lower-frequency range due the above-mentioned flutter effects can easily be seen from the left side of the response curve of Fig. 1F.

A very important factor in the design of the steel recording devices is the shape and the quality of the iron used for the recording and pick-up magnets. All the work done in the last 30 years has been concentrated mainly upon the shape of these magnets and the selection of a suitable iron. At present an iron is used in the recording and pick-up magnets which has a retentivity of a negligible value. This iron which is only made in Sweden is called "Holz-Kohlen-Eisen" (charcoal-iron). The steel wire or steel tape used at present is made of an iron of the highest retentivity obtainable, and also is exclusively imported from Sweden.

Another important point often responsible for failure in the past is an incorrect distance between recording magnet (and naturally the pick-up magnet), and the steel wire or steel tape. Contrary to the simplified scheme of Fig. 1C, which shows the method of recording and reproduction, two magnets are used in modern steel recorders. Both are arranged in such a manner that they can be moved closer to each other by means of a very fine micrometer drive. The air gap is of great importance to the frequency curve finally obtained, as Fig. 1G indicates.

In Fig. 1G are shown three curves concerning a steel-tape recorder of modern design, which operates with a tape speed of 1.5 meters per second (4.9 ft.). The response curve obtained when the air gap is too narrow is indicated by curve a. Curve b shows the response which is obtained by means of an air gap too broad. The final response curve obtained with the same steel recorder but with properly adjusted air gap and used in connection with an equalizer circuit is demonstrated by curve c. (In Germany, the following constants are used, states the U. S. Dept. of Commerce; ribbon width, 3 mm.; thickness, .08-mm.; speed, 1.5 mm.-per-sec.; length, for 30-min. recording, 2,700 m. Reproduction quality is rated as "good"—same as "wax record."—Editor)

PRESENT USE OF "IRON" RECORDINGS

The British Broadcasting Company uses steel recordings only to store the news bulletins radiated over domestic stations during the daytime for a play-back over the Empire short-wave stations. (Music, however, is recorded on wax, because of the limitations of the response curve of steel recordings.) After the wire has been played back it is led in front of a powerful erasing magnet which "erases" the previous recordings, and makes the same steel tape or steel wire ready for recording of the news bulletins of the next day.

The German Broadcasting Company, especially, the transmitters in Berlin and Hamburg and frequently the German short-wave transmitter, are using steel recordings for an interesting and much-liked feature of their respective programs. This feature is well known in Germany and abroad under the heading, "The Echo of the Day." The German Broadcasting Company has some sound trucks which are completely equipped with steel recording outfits. These trucks are sent each day through the streets of

Please Say That You Saw It in RADIO-CRAFT

Berlin, Hamburg, etc., and interview people on the streets about their professions, and opinions concerning interesting daily events. The cars also secretly catch the talk of bystanders when an accident has happened, etc. The interviews are recorded on the steel tape and then transmitted in the evening. *Letters to the German broadcasting station indicate that this feature is the best liked part of the daily program.*

(France now has its mobile trucks for making magnetic "spot" recordings of news events, when and where they occur. See page 556.—Editor)

INTERNATIONAL RADIO REVIEW

(Continued from page 541)

fidelity of the radio receiver amplifier and speaker.

THE "FOTOTUNE" DIAL

A NEW TYPE of dial has just been placed on the market in England, according to an announcement in *The Broadcaster and Wireless Retailer* (London).

This new dial which is used in several new receiver models projects the name of the station on one of two translucent screens—one for the broadcast band and the other for the long-wave stations. The dial indicator at the same time indicates the wavelength on which the station is being picked up. See Fig. D.

The two wave ranges of the set are chosen by simply depressing or raising the tuning dial.

This dial is a marked relief from the complicated designs which are found on many foreign sets (and American ones, too, for that matter).

A "MEGGER" HAND GENERATOR

THE "MEGGER" type of resistance indicator is used much more in Europe for high-resistance indications than in the U.S. Since this type of resistance indicator requires a high voltage for operation, the need for tiny generators which will supply the required potentials can be understood.

The unit shown in Fig. E was described in the latest issue of *L'Industrie Francaise Radio-Electrique* (Paris). It is a hand-operated unit, having a crank on the side which is geared to the armature of the generator unit.

AN ITALIAN RADIO CHASSIS

AN ALL-WAVE SET of unusual design was shown in the latest issue of *Radio Industria* (Milan). The tuner, shown in Fig. F, is entirely separate from the main chassis. It is a self-contained, and is connected to the rest of the set by only 4 or 5 wires. This tuner contains the R.F., 1st-detector and oscillator coils; the tuning condensers; wave-change switch; and, dial-drive mechanism.

The wave-change switch is equipped with a fan-shaped indicator with the wave-band indications printed in such way that only one shows at a time at the window in the set cabinet.

The main chassis (Fig. G), on which the tuner is supported on springs, contains the tubes, transformers, resistors, condensers and I.F. coils, as well as the indicator portion of the dial.

By dividing the set in this way, the tuner can be more carefully aligned and constructed—and vibration and heating of the regular chassis will have the least effect on its alignment.

SIMPLE CABINET-RESONANCE SUPPRESSOR

MUCH HAS been said lately concerning cabinet resonance, its ill effects and suppression.

A recent issue of *Practical and Amateur Wireless* (London) contained a simple method for padding the interior of the set cabinet to suppress any vibrations which might be set up. This palliative consists of lining the interior of the speaker compartment (especially the sides) with thick layers of newspaper in such way that the edges are held down rigidly, only the middle being allowed to bulge—in this way, air pockets are formed.

This is a trick which most experimenters and radio beginners can try since it does not in any way disturb the set itself.

These Splendid Books FREE!

Think of it! 2 books full of invaluable information, to be had for just the mailing costs! One with 20 complete transmitter designs including 12 tested transmitter RF section designs and 8 modulator and speech amplifier designs. Circuits, complete parts specifications, inductances, etc. all included.

Ten complete designs for public address amplifiers in the other book. It includes one for every purpose, from 3 Watts to 30 Watts output, with complete parts lists for each.

These books should be in every amateur's technical library. They are invaluable for reference purposes. Just 22 cents in stamps, to cover postage, brings them both to you, or get them from any Standard Distributor. Send for your copies today.

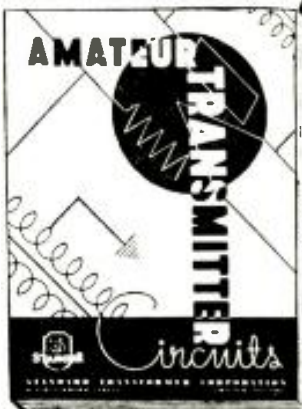

STANDARD TRANSFORMER CORP.

856 Blackhawk Street,

Chicago, Illinois

MAIL THIS COUPON!

STANDARD TRANSFORMER CORPORATION,
Dept. C, 856 Blackhawk Street, Chicago, Ill.
I am enclosing 12c for Transmitter Manual.
I am enclosing 10c for Amplifier Manual.

Name Address

City State

Try OXFORD...

if you want to hear the best performance of which any radio or P.A. set is capable, hook it up with one of the new OXFORD CHROMAVOX High-Fidelity SPEAKERS. There is a size and type FOR EVERY RADIO, PUBLIC ADDRESS and THEATRE NEED.

It is hard to convey in type any real idea of the rich, full tone that pours out from one of these scientifically designed OXFORD units. To really know how far in advance of the field the OXFORD line is today, try the units in actual service.

See your Jobber or for full information on type of equipment you need

WRITE US "ATTENTION DEPT. C"



OXFORD-TARTAK RADIO CORP.
350 W. Huron St. Chicago, Illinois

RAYTHEON

TRADE MARK

4-PILLAR RADIO TUBES

Write for FREE 1936 Tube Chart
RAYTHEON PRODUCTION CORP., Dept. E-3,
30 East 42nd St., New York, N.Y.

SAVE \$\$\$ on RADIOS

BUY DIRECT 30 day trial FREE CATALOG

Buy at factory prices. 30 models to choose from AC-DC, All-wave, Farm, Car and Metal Tube models. Send postcard for NEW 1936 Bargain Catalog FREE. Get details of 30 day TRIAL plan and Agent-User proposition. Also ask for our NEW Parts Catalog.

ZEPHYR RADIO CO.
11708 Livernois, Detroit, Mich. DEPT. 223

Please Say That You Saw It in RADIO-CRAFT

OVER 310 TUBE TYPES

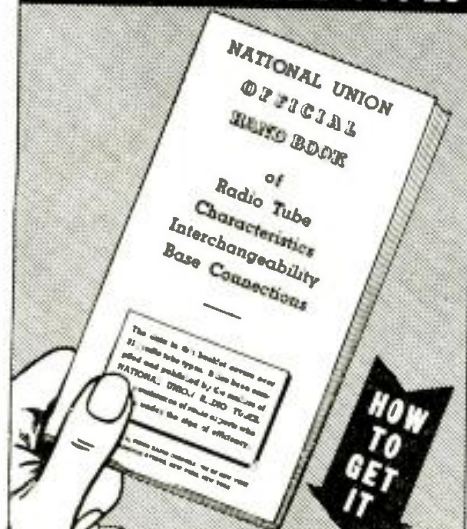

HOW TO GET IT

Greatest compact pocket size compilation of vital radio tube information in the industry!

1. If you are a National Union radio tube dealer ask your distributor for a free copy.
2. If you are not a National Union tube dealer, send ten cents (stamp, or coin) to cover postage and handling OR
3. Send coupon asking for name of nearest National Union distributor from whom you can get a copy free.

NATIONAL UNION RADIO CORP. of N. Y.
570 Lexington Avenue, New York, N. Y.

Who is my nearest N. U. jobber?

Name _____ RC336
Street _____
City _____ State _____

QUALITY VERNIER DIALS

Type 2211 is a three window, four inch friction drive bakelite moulded dial, Egg-shell, black finished, this dial enhances every job. Clockwise rotation of 0-100 through 180 degrees. Ratio 9 to 1. List \$1.75



Type 2213—three inch single window, egg-shell, black bakelite dial, 0-100 clockwise rotation through 180 degrees. 7 to 1 ratio, vernier drive. List \$1.50

Available at all distributors and mail order houses. For complete catalog send 10c in postage or coins to cover cost of handling and mailing.

Other models from 75c. Also a complete line of precision amateur experimenter's parts.

INSULINE CORP. OF AMERICA
25 Park Place New York, N. Y.

We SPECIALIZE in the Design and Manufacture of Public Address Amplifiers
SEND FOR FREE CATALOG!
Bulletin No. R-1035

Describes in detail 86 different models and complete P.A. Systems ranging up to 200 audio watts output. 6 volt; AC; DC.

Buy Direct from Manufacturer AND SAVE BIG MONEY
Coast to Coast Radio Corp.
599-R Sixth Ave. New York, N. Y.

DIRECTED SOUND—A NEW METHOD OF "INDIVIDUAL" RECEPTION

(Continued from page 539)

and somewhat larger than the speakers. These cases are made practically airtight and are insulated very carefully with heavy sponge rubber or other high-grade insulating material, to prevent the transmission of vibrations from the speakers to the cases and so to the room. The sponge rubber insulates the reproducer from the seat on which it rests, and by which it is attached to the case, so that the physical vibrations of the reproducer are not transmitted to the case, and it also covers the entire inside of the case—is molded into the case—every particle of which is covered, so that neither the physical vibrations of the speaker nor the more or less violent air vibrations inside the insulation of the case can reach the case and so be transmitted to the room.

Then there is a front-plate, the outer surface of which also has heavy sponge rubber molded to it, and this front-plate is held in place by a closure plate, which is held fast to the case by means of a number of screws, which pass through the front plate and speaker, and the insulation under the reproducer into an anchoring ring attached to and reinforcing the case. These screws are also insulated (as shown). The inside of the front-plate is shaped to a special curve, so that all the air which is moved by the diaphragm over its entire surface, is gathered together, and concentrated and accelerated outward through a small central opening, which may be anything from 3/8- to 3/32-in. in dia., according to circumstances.

The curve of this front-plate is designed to gather together all the air moved by the diaphragm and to concentrate and accelerate it forward and to produce a smooth and constantly accelerating motion of the air, thereby reducing eddy currents, distortions, resonances, etc., to a minimum, and so to force this air, in the form of a small stream of vibrations, which may be of very great intensity, out through a small central opening and to deliver this stream of vibrations close to, or, if desired, directly into, the ear.

It will be readily seen that the concentration and acceleration of the air under these circumstances is enormous—neglecting the "give" in the diaphragm and the slight loss in compressing the air, as well as slight frictional losses, it would be better than 4,000 to 1. Therefore, a very small motion, even a microscopic motion, of the diaphragm, will produce a loud sound when delivered close to the ears of the listener. In this way, the listener in the chair can have all the volume of music that he desires, with an exceedingly small motion of the diaphragm and, therefore, is always listening to music which is produced in the most beautiful range which the diaphragm has—THE RANGE OF EXCEEDINGLY SMALL VIBRATIONS.

THE CONTROL CIRCUIT

A switch controls the operation of the unit (Fig. 2). By turning it to the No. 1 position the chair reproducers are actuated; by turning to the No. 2 position the regular loudspeaker of the set is operated; and, the No. 3 position simultaneously connects both the chair and the loudspeaker. By turning to the No. 4 position the radio set is cut off, and a microphone and amplifier cut in for conversation between a hard-of-hearing person seated in a silent radio chair, and the remaining person or persons in the room. A separate volume control for the microphone permits variation of the "chair's" output from a whisper to anything that the ears will stand. (The power is such that people with normal hearing can't begin to endure it when it is turned up toward full volume.)

Also, a separate volume control is inserted in the voice-coil circuit of the chair reproducer, so that its audio output (room conversation or radio program), which is very much stronger in the chair than in the rest of the room, may permit the reception facilities of the listener in the chair to be entirely independent from the listeners in the rest of the room.

Another and strikingly new field into which this Cahill silent radio chair works beautifully, is in *binural* hearing. So far as conversation in the room for the hard-of-hearing is concerned, it is greatly improved and made much more vivid and life-like, by binural treatment. By using separate microphones, separate amplifiers

TYPEWRITER BARGAIN

10-DAY FREE TRIAL OFFER

FREE HOME TYPING COURSE



ONLY 10¢ A DAY

BRAND NEW MODEL No. 5

REMINGTON PORTABLE

● A brand new Remington for only 10c a day. An easy, practical Home Typing Course FREE. With it anyone quickly becomes expert on this machine... the most rugged, dependable portable made. Not used or rebuilt. Standard 4-row keyboard. Standard width carriage. Margin release on keyboard. Back spacer. Automatic ribbon reverse. *Every essential feature of big office typewriters.* Carrying Case FREE. Try it for 10 days without risking a cent. If you don't agree it is the finest portable at any price, return it at our expense. Don't delay. Without obligation, write now.

Remington Rand, Inc., Dept. 189-3, 205 East 42nd Street, New York, N.Y.

MAILING LISTS



GET OUR FREE REFERENCE BOOK and MAILING LIST CATALOG FREE

Gives counts and prices on accurate guaranteed mailing lists of all classes of business enterprises in the U. S. Wholesalers—Retailers—Manufacturers by classification and state. Also hundreds of selections of individuals such as professional men, auto owners, income lists, etc.

Write today for your copy

R. L. POLK & CO.

Polk Bldg.—Detroit, Mich.
Branches in Principal Cities

World's Largest City Directory Publishers
Mailing List Compilers. Business Statistics. Producers of Direct Mail Advertising.

BUILD IT YOURSELF

Can be built by anyone familiar with the use of hand tools. Includes 5000 ft. of wire, rivets, etc. The house and the trailer are built in the same manner. Plans are complete and easy to follow. Fully illustrated. Price \$1.00. Factory job well done. Over \$1,000—hold it yourself and save 75%.



The Trailer Plan Shop, 510-919 N. Michigan Ave., Chicago

RADIO COURSES

RADIO OPERATING: Prepare for Gov't License Exam. ● RADIO SERVICING: Including Short Wave ● AMATEUR CODE ● New Course in ELECTRONICS: Day and Evening Classes. Booklet Upon Request
New York YMCA Schools
4 W. 64th Street, New York City

Please Say That You Saw It in RADIO-CRAFT

(or a dual-channel amplifier) and separate lines for each speaker on the chair, the hard-of-hearing listener at once gets 3-dimensional hearing and knows instantly just where each voice is coming from without having to look—something which is impossible with the present aids for the deaf, or even in these chairs if only one microphone and one amplifier feed both speakers. Also, the beauty and naturalness of orchestral music, acting and general radio programs, when handled in a binaural way in broadcasting, are greatly increased. So these silent radio easy chairs fit beautifully into the next advance in radio broadcasting—binaural broadcasting—and when it comes, users of the chairs will find that this device is made to order for it. Any broadcast company which can obtain the use of a second broadcast frequency, merely by the use of an additional microphone and an additional transmitter can broadcast binaural programs which anyone in a "silent" chair can pick up in all their greatly increased beauty.

If we look at the past history of radio and consider the lightning-like rapidity with which it has developed, and the amazing inventions which have been made, and their rapid reception by the public; and when we consider that the beauty and pleasure of music, singing, acting, etc., are so enormously enhanced by binaural transmission and reception—3-dimensional hearing; and since it is believed that the use of such radio chairs will spread rapidly, we probably do not have long to wait before binaural reception will be common.

Dr. Orestes H. Caldwell made the following pertinent remarks recently: "The new 'high fidelity' radio sets with response up to 7,000 and 8,000 cycles, may aid in forcing a return to headphone listening, as a result of the distorting echoes which result in the average room with these high-frequency tones. Although the broadcasters and radio-set makers provide for perfect reproduction, the listener's own room may produce echo distortions which manifest themselves at various positions within the room and destroy much of the artistic effect so carefully preserved by the radio equipment. But if the output of the radio set is fed to a high-fidelity headphone, the listener will hear only the perfection of the music itself without any distorting echoes."—Editor

NEW "LIGHTNINGARIUM"

Probably the only building of its kind is one recently erected, at the Pittsfield Works of G.E., for extensive studies into the vagaries of lightning. It is equipped with a periscope and, on the roof, a specially-designed, 12-lens camera operated at high speed via a motor. The 12 "eyes" permit observation and photographic recording of flashes over 360 deg., within 20 mi. distance.

A BUILT-IN AERIAL TUNING SYSTEM

USERS of all-wave and short-wave receivers will be interested in the details of a built-in aerial tuning unit featured in the newest Philco receivers. The results obtained from this equipment are equivalent to those which would be provided by the use of a separate tuned antenna for each tuning band on the set. Yet only one aerial is used; this being tuned by a section of the band switch. When this switch is turned to select any tuning range, the antenna is automatically set at the proper value for that entire band.

The results of this tuning system are very marked, showing up in the form of increased signal strength and decreased noise.

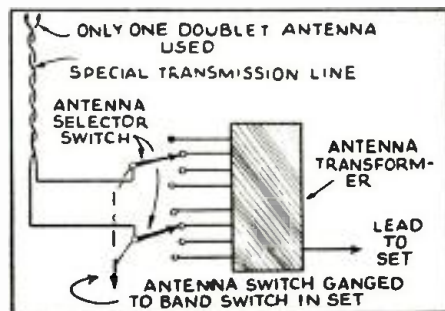

WHAT THE P.A. BEGINNER SHOULD KNOW

(Continued from page 535)

gets hung up for a lot of costly equipment. He should submit estimates in writing, obtain verifications or orders from his customer, insist on a contract to protect his own investment and in general conduct himself like a business man and not a mere tinkerer. Capable technicians who want to advance themselves out of the servicing class would do well to engage in some home study courses in business management and law, and learn to dress and talk like gentlemen and not like mechanics. In other words, acquire a "front," and the dirty work of installation will take care of itself. This frank advice is based on the writer's contact with and observation of many hundreds of purchasers and users of sound equipment.

On the technical side, the P.A. beginner too often approaches the field without a proper appreciation of amplifier design and operation. A P.A. amplifier is a whole lot more than a mere "audio amplifier," and bears only a faint resemblance to the A.F. channel of the usual radio receiver. It has enormously higher gain, and is, therefore, extremely sensitive to conditions that never affect a radio receiver. A single unshielded lead or a poor ground may cause the amplifier to hum so badly that reproduction of voice or music becomes impossible.

The beginner frequently concentrates too much attention on the amplifier itself and tends to overlook the importance of the associated units, particularly the reproducers. The amplifier alone, regardless of its own quality, does not determine the final output issuing from the speakers. The old adage about a chain being as strong as its weakest link applies here with particular force. For example, a 15-W. amplifier with a pair of 14-in. auditorium-type reproducers will actually deliver more usable sound than a 30-W. amplifier with two ordinary 12-in. radio-type speakers! It is actually less costly and better, to buy a cheaper amplifier with better loudspeakers than a more expensive amplifier and cheap reproducers.

"Should I buy or build my amplifiers?" This is a commonly asked beginner question. Apparently a P.A. amplifier is nothing more than an overgrown audio unit, but any Service Man who tries to build a high-gain amplifier quickly develops a wholesome respect for engineers who specialize in A.F. circuit design.

It is really cheaper to buy a ready-made, factory engineered amplifier than to buy similar or identical parts and to try to do the assembly work yourself. If you're in P.A. to make money you can't afford to spend a week taking the bugs out of a recalcitrant amplifier, and if you sell a half-baked unit it will bounce back at you very quickly. Amplifiers are given much harder service than radio receivers, often being kept running for days at a time, and defects therefore show themselves in short order. Your installation must stand up in the field. Nothing will ruin a promising P.A. business more abruptly than an amplifier that quits in the middle of an important ceremony or function—and that's always when they do go haywire!

Beware of amplifiers made of surplus radio parts. A lot of these components are floating around and are causing the sound business more black eyes than people realize. The most insane imaginable ratings are being attached to light, inadequate transformers and chokes, and tubes are being called on to deliver more power than is within their own theoretical limits.

In choosing an amplifier, read the specifications of different makes with great care, and compare overall sizes and weights. There is no substitute for iron in good transformers and chokes, so, a comparison of amplifier weights is significant. There is obviously something rotten if one so-called 15-W. amplifier weighs 28 lbs. and another of exactly the same rating weighs 40, or if one so-called 100-W. output transformer is only about half the size of another transformer also rated at 100 W. Such scrimping is permissible in a radio receiver, which is merely an instrument of amusement, but is suicide in an amplifier sold for commercial purposes. The writer cannot emphasize too strongly the folly of "cheapness." In the end, cheap apparatus is the most expensive, for one replacement of a broken-down unit takes all the initial profit out of the job.

This article has been prepared from data supplied by courtesy of Wholesale Radio Service Co., Inc.

Learn RADIO from REAL RADIO ENGINEERS!



Mandall Clough
Chief Engineer,
Cloth-Brands Co.

E. E. Gramer
Chief Engineer,
Standard Transformer Co.

Earl E. Masad
Chief Engineer,
Zenith Radio Corp.

M. C. Tittle
Chief Radio Engineer,
Grundy Radio

D. W. Witten
Service Manager, Philco
Radio & Television Corp.

Dr. C. M. Shubbers
Radio Engineer,
P. R. Muller & Co.

Train Now at Home for Good Pay Spare-Time and Full-Time Jobs That Pay Up To

\$75 A WEEK

If you're dissatisfied with small pay—and an uncertain future—here's an opportunity that's too good to miss. Get my big FREE book, "RADIO'S FUTURE AND YOURS." This book tells how you can learn at home under the supervision of factory engineers, to make more money almost at once in Radio—how to make Radio your life's work, or use it to pick up \$5 to \$20 a week extra in your spare time.

More Opportunities Than Ever Before

Radio is still forging ahead. 1935 was its biggest year. Over 5 million new sets sold. Over 30 million dollars paid for service alone in 1935. Where only a few hundred men were employed a short time ago, thousands are employed today. And where a hundred jobs paid up to \$7 a week—there are thousands of such jobs today—many paying even more. New full time jobs and spare time jobs are being created all the time. Get my book and see how easy you can get started.

"Shop Training" for the Home

R-T-I Training is different. It comes to you right from the heart of the Radio Industry—right out of the factories where Radio sets and other vacuum-tube devices are made. It was planned and prepared and is supervised by big radio engineers IN these factories—by men appointed for the purpose. R-T-I will train you as the Radio Industry wants you trained.

Television, Photo Electric Cells, Public Address Systems Included

Radio service work is plentiful but it's only the starting point in R-T-I Training. From there you'll go through the whole field of Radio and Electronics. You will learn about every new development, including Television so you'll be ready when Television breaks. You'll also learn the big money subjects such as Aviation and Auto Radio; Public Address Systems; how to handle Photo Cells; Sound Picture Recording, Etc.

4 Working Outfits Furnished

Start almost at once doing part time radio work. I furnish 4 outfits of apparatus that you build into test equipment with which you can do actual jobs and earn extra money. My Training pays its own way and you get your money back if not satisfied. Age or lack of experience is no handicap.

Free Book

Find out why R-T-I Trained men get "Quick Results" and "Big Results." Send for "Radio's Future and Yours" today. It tells about Radio's amazing opportunities. It describes my approved training—what R-T-I students are doing and making. It gives the names of 50 firms who endorse and recommend R-T-I. It's FREE!

Ray D. Smith,
President
RADIO AND TELEVISION INSTITUTE
Dept. 223, 2130
Lawrence Ave.,
Chicago

Makes \$600 in One Month

Herbert R. Thompson, Girman, Texas, started making money with 12 lessons finished. He says, "Because of my R-T-I Training I made \$150 in September and over \$600 in October 1935. It pays to be R-T-I Trained."

Big Money in Auto and Police Radio Work

W. H. Carr, 402 N. 10th St., Kansas City, Kans., R-T-I student, has charge of 35 radio equipped Police and Fire Department cars. He gets \$230.00 a month and free auto, gas, oil, etc. He says, "If I had not taken your course I would not be able to hold this job."

MAIL COUPON FOR FREE BOOK

RAY D. SMITH, President
Radio and Television Institute (R-T-I)
2150 Lawrence Ave., Dept. 223
Chicago, Ill.

Dear Mr. Smith: Without obligating me, send FREE Book about spare-time and full-time Radio opportunities and how I can train for them at home.

Name.....
Address.....
City.....State.....

Please Say That You Saw It in RADIO-CRAFT

Every Job's a SNAP!



"I USE ALLIED SERVICE EQUIPMENT"

"This one looked like a terror—but it turned out to be a set-up. The toughest job in the world can't faze me when I use ALLIED Service Equipment. My customers like the way I locate haywire spots in a hurry. I give them speedy repair service because short cut methods are every day stuff to me. My reputation is built on ALLIED Test Equipment and on ALLIED parts. That's why I say—every job is a snap when you've got ALLIED behind you."

SEND FOR FREE 1936 CATALOG. Dept. D



ALLIED RADIO
833 W. JACKSON BLVD.
CHICAGO, ILLINOIS

The RACO

One Tube (19 Tube) Transceiver



An inexpensive 1-tube 5 and 10 meter transceiver. This extremely efficient transceiver is recommended for the short-wave enthusiast who is interested in exploring the fascinating 5 and 10 meter bands. This circuit utilizes the type 19 two volt twin tube, and is exceedingly sensitive since the super regenerative principle is employed, when the receiving position is switched on. Batteries required are two 1½ volt dry cells and 90 to 135 B supply. Complete kit with (2) 5-meter coils and dial.

\$4.75

less batteries.
● Cabinet, 75c. ● 10 meter coil, 50c ● Wiring, assembly, \$1.50. ● Tube, 65c.

Write in for new Free List of 5- and 10-Meter Equipment

RACO RADIO CONSTRUCTORS LABORATORIES
136 Liberty St., N. Y. C., N. Y. Dept. RC4



1910-1936

Catalog and Descriptive material upon request.

CORNELL-DUBILIER
CORPORATION
4347 BRONX BOULEVARD
NEW YORK

NEON

Prepare yourself quickly for today's biggest opportunity—NEON or "gaseous tube" lighting—most widely used medium of lighted displays, the future's greatest source of illumination. Splendid future. Trained men needed in every locality. Start now while the industry is still new!

FREE Booklet describes NEON'S opportunities and complete data on the practical C. L. home-study course. Low enrollment fee will amaze you. **WRITE TODAY!**

COMMERCIALITE LABORATORIES, Box 47-R, Omaha, Nebr.

2-DOZEN IDEAS FOR YOUR SERVICE SHOP

(Continued from page 540)

units may have various values of resistors, condensers, R.F. and I.F. coils, R.F. and A.F. chokes, transformers, tuning condensers, and coils (all-wave and broadcast band), universal input and output transformers, etc.

6) Have lights (with conical shades or reflectors) so arranged that they can be slid along a trolley wire to any position over the test panel.

7) Have a small, flexibly-mounted spotlight arranged on an arm attached to the bench for concentrating light on any job. (Fig. 1A.)

8) Have various types of aerials available at the service bench with outlets at various points on the bench.

9) Keep a clock right in front of you on the service bench for accurate estimation of the time spent on service jobs.

10) Use an "adjustable" chassis cradle mounted on castors, with a light over it, so that it can be raised or lowered. The angle should be adjustable.

11) Use a fixed crystal detector and phone unit for quickly checking the operation of the various R.F. stages.

12) Build a small "signal detector" consisting of a small all-wave 1-tube oscillating-circuit receiver with a calibrated dial and an amplifier. It is capable of being used as a grid-dip meter, or oscillating-type wavemeter for detecting the exact frequency of the oscillator in any super-heterodyne receiver under test, or as a means of determining if a signal is being received through any tubes up to the demodulation of the radio under test by clipping the lead from the signal detector to the proper place.

13) Use a phonograph record in place of an A.F. oscillator to modulate the R.F. signal for adjusting high-fidelity receivers.

14) Have a set of A.F. test records that cover the entire high-fidelity A.F. range. When these are played through a good pickup and A.F. amplifier they may be used for checking the performance of A.F. amplifiers, loudspeakers, phono. pickups (used alone), etc.

15) Have felt or sponge-rubber pads on which to rest the set chassis while it is being repaired. This prevents damage to frail coils, wiring, etc. (Fig. 1B.)

16) Build a service manual holder, which will hold the manual open at any desired page, and can be mounted above the bench panel on a ball and socket joint so that it can be swung or tilted to any position. (Fig. 1C.)

17) Have an electrically heated, well-insulated chassis heating and cooling oven, in which the entire receiver may be placed in order to locate thermal abnormalities which are causing intermittent reception, noises, etc.

18) Have a D.C. powerpack at hand for supplying high voltage to test condensers for shorts, breakdowns, leakage, etc.

19) Have a small portable 6 V. D.C. to 110 V. A.C. "inverter" for furnishing the power to test equipment such as tube checkers, etc. when working in districts where battery-operated receivers are often encountered.

20) Have a small motor-driven hair drier for blowing out the dust from set chassis and loudspeakers. (Fig. 1E.)

21) Have one or two midget receivers at hand for customers' use while sets are being repaired.

22) Have a good receiver in the shop at all times to use as a standard of comparison in pointing out to the customer the faults of, or deficiencies in his own set.

23) Have a standard type of tag and stub to put on all sets left for servicing. The ticket should contain definite spaces for filling in:

- a) Name, address and telephone number of customer
- b) Time and date set is received in shop
- c) Time set is promised
- d) Make, model and serial number of set
- e) Nature of the trouble in receiver
- f) New parts and labor necessary

After a set is repaired, the Service Man should fill out the tag, itemizing all parts and labor used on the set, for transfer to the books. Part (e) of the tag could remain in the files as a "case history."

24) Keep a cross-indexed reference system filed on large sheets in letter files containing clippings from magazines, house organs, etc., which contain useful service information.

This article has been prepared from data supplied by courtesy of Radio & Technical Publishing Co.

12 BOOKS TO HELP YOU LEARN MORE ABOUT RADIO



Illustrated at the right and left are two books in the Radio-Craft Library Series.



THE RADIO-CRAFT LIBRARY SERIES—a most complete and authentic set of volumes—treats individually, important divisions of radio. Each book has been designed to give you the opportunity to learn one or more branches of radio. The authors of the books are well-known to everyone. Each is an expert radio man; an authority on the subject—each is thoroughly familiar with the field which he represents.

All Books Uniform

The volumes in the RADIO-CRAFT LIBRARY SERIES are all uniform, 6 x 9 inches. Each book contains on an average of 50 to 120 illustrations. The books are printed on an excellent grade of paper which makes the type easy reading.

Here Are the Series:

Book No. 1
RADIO SET ANALYZERS
And How to Use Them By L. VAN DER MEL

Book No. 2
MODERN VACUUM TUBES
And How They Work By ROBERT HERTZBERG

Book No. 4
MODERN RADIO HOOK-UPS
The Best Radio Circuits By R. D. WASHBURNE

Book No. 5
HOW TO BECOME A RADIO SERVICE MAN
By LOUIS MARTIN

Book No. 6
BRINGING ELECTRIC SETS UP TO DATE
By CLIFFORD E. DENTON

Book No. 7
RADIO KINKS AND WRINKLES
For Service Men and Experimenters
By C. W. PALMER

Book No. 8
RADIO QUESTIONS AND ANSWERS
By R. D. WASHBURNE

Book No. 9
AUTOMOBILE RADIO AND SERVICING
By LOUIS MARTIN

Book No. 10
HOME RECORDING AND ALL ABOUT IT
By GEORGE J. SALIBA

Book No. 11
POINT-TO-POINT RESISTANCE MEASUREMENTS
By CLIFFORD E. DENTON

Book No. 12
PUBLIC ADDRESS INSTALLATION AND SERVICE
By J. T. BERNSELY

BIG DISCOUNT OFFERED

When Five (5) Books or More Are Ordered, Deduct 20% from Your Remittance

GERNSBACK PUBLICATIONS, INC.
99 Hudson Street, New York, N. Y.

MAIL THIS COUPON TODAY!

GERNSBACK PUBLICATIONS, INC.
99 Hudson Street, New York, N. Y.

I have circled below the numbers of books in the RADIO-CRAFT LIBRARY SERIES which you are to send me, and have deducted 20% for ordering five (5) books or more. I have included my remittance in full, at the price of 50c each, when less than five books are ordered.

The amount of my remittance is..... (stamps, checks or money orders accepted). Circle numbers wanted:

1 2 3 4 5 6 7 8 9 10 11 12

Name

Address

City State.....

All books are sent postage prepaid

RC-336

Please Say That You Saw It in RADIO-CRAFT

LATEST RADIO EQUIPMENT

(Continued from page 542)

technicians and others. Has 4 drawers (3 of which are divided into small sections), and large shelves for tools, etc. Finish is hard black crackle enamel. Length is 24 ins. (Available as a premium.)

SOCKET-HOLE PUNCH KIT (933)

HERE is a simple set-up for making holes in sheet aluminum or thin steel chassis to accommodate tube sockets. The idea is to center the punch over the die, whang the punch with a hammer and, presto!, there's the socket hole! Kit includes 1 master die (for holes $\frac{1}{8}$ -in. under the diameters of 1 $\frac{1}{2}$, 1 $\frac{1}{4}$, and 1 in.), 3 punches, 1 centerpin, 1 centerpin cap, and 1 counter punch (for removing the slug).

SQUARE METER (934)

VERY modern in appearance, this meter is of entirely new construction throughout. Scale is exceptionally long—4 $\frac{1}{2}$ ins. The bakelite case is 4 $\frac{1}{2}$ ins. sq. at the front and is circular at the rear, fitting into the regular 2 $\frac{3}{4}$ -in. hole. Movement is unusually rugged, very sensitive, and has sapphire bearings. Available in standard ranges in A., V., and ma.

MIDGET "MIKE" TRANSFORMER (935)

A DIMINUTIVE microphone transformer has been developed which measures only 1 $\frac{1}{2}$ x 1 $\frac{1}{8}$ x $\frac{7}{8}$ -in. deep; the mounting tabs add $\frac{3}{8}$ -in. on either side. Available to specifications.

OCTAL SOCKET FOR BREADBOARD MOUNTING (936)

AN 8-PRONG ("octal") socket is now available to the experimenter who wishes to test out his metal-tube circuits on a breadboard, before settling upon a more permanent metal-chassis layout and wafer sockets.

CRYSTAL MICROPHONE AND PREAMPLIFIER (937)

CALLED "Wave-equalized," this combination gives a substantially flat characteristic over the entire range. The "sound-cell" (diaphragm-less) type of head is used. The entirely enclosed high-gain preamplifier uses 1-6C6 and 1-76. A special 7 ft. cable connects the head with the amplifier.

DYNAMIC SPEAKER (938)

WHILE produced as a low-cost unit, this new speaker is highly efficient. Available in dustproof and non-dustproof models; with curved or straight cone designs; and in 8 (illustrated) or 10 in. size. Standard field coil (with or without cover) and transformer ratings may be had.

CAPACITY BRIDGE (943)

THIS capacity bridge is made mainly for testing small values, not only in the way of actual condensers, but all other small capacities, such as auto-radio aeriels and house antennas. The range covered is 0 to 10,000 mmf. The only batteries required are 2 small flashlight cells

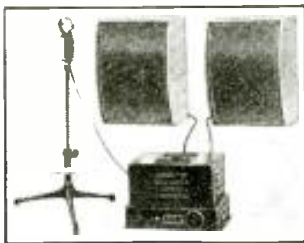
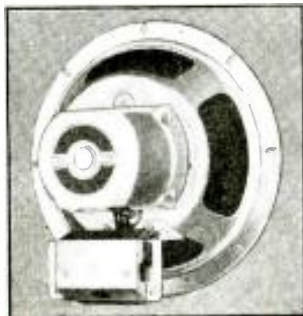

No. 937, extreme left. A crystal mike and preamplifier.
No. 938, left. An efficient reproducer.
No. 939, below. A hi-fidelity P.A. System.



Enjoy Success Now!

Plan Your Future In A Field Where Training Pays

SERVICE & PUBLIC ADDRESS ENGINEERING

for experienced servicemen

This new home-study course was written especially for professional Servicemen who feel the need of Technical Training, to keep alert with new Radio developments and ahead of growing competition. It covers all branches of Servicing, Public Address Systems, the latest works in Vacuum Tubes, Circuits, Acoustics, and the treatment of auditoriums.

Free! 48 Page Catalog Sent To You On Request

This interesting, illustrated booklet gives complete details about all CREI courses, the school, equipment and faculty. It tells what we have done for others and what we can do for you, IT'S FREE—for the asking.

CAPITOL RADIO ENGINEERING INSTITUTE

14th and Park Rd. Dept. RC-3

Washington, D. C.





THOR'S Latest P.A. 5-Tube Hi-Fidelity Amplifier

Has less than 2 dB variation between 20 to 14,000 cycles. Rated Gain 75 dB. Power output 16 watts continuously and peak of 20 watts. This sensational performer is built around the following tubes: (1)-RCA83V—(1)-RCA56—(1)-RCA57—(2) 2 B6's. Tubes Specially priced at \$3.95.

Completely wired and tested Ready to operate	less Tubes less Speaker	\$14.95
Rola G 12" Hi-Fidelity speaker with output transformer to match.....		\$10.45
Rola 12" K-12 speaker to match.....		\$3.95

Order direct from this ad.
MAIL ORDERS PROMPTLY FILLED



THOR RADIO

167 GREENWICH ST. NEW YORK, N. Y.



totaling 3 V. The current drain is only about 15 ma., so that the cells will last a long time.

The battery is used to operate a small buzzer which supplies a signal to a pair of headphones, to tell when the dial is at the correct setting. Correct setting of the dial is indicated by the point where the signal decreases to the lowest point. The tester will indicate whether the aerial or condenser under test is shorted or open.

There are only 2 leads from the instrument, a red and a black. When testing an auto antenna, the red connects to the antenna lead and the black to the car frame. This polarity is not necessary on condensers.

if...

YOU WANT YOUR OBSOLETE SET ANALYZER OR TUBE CHECKER

Modernized

WRITE FOR OUR PLAN

MENTION MODEL NUMBER OF YOUR OLD INSTRUMENT	MODERNIZATION DIVISION DEPT. 'C'
---	----------------------------------

PRECISION

APPARATUS CORPORATION
821 EAST NEW YORK AV. BROOKLYN, N. Y.

Please Say That You Saw It in RADIO-CRAFT

Gosh! It's a DANDY!



"OF COURSE I USED ALLIED PARTS"

What power! Take a tip: Hams and Experimenters—you can't beat ALLIED matched kits when you're building your own. I never knew it would be so easy to build this set. Every part fits right; all I did was follow the diagram and presto—here it is! Say, if ALLIED can make set-building this easy—I'm going to build more sets. ALLIED says they can supply FREE parts lists for any circuit. I'm going to take 'em up on it. They've got what I need and they save me money. I'm darned glad I've got an ALLIED Catalog handy—it certainly pays!

SEND FOR FREE 1936 CATALOG. Dept. D

FREE

ALLIED RADIO
833 W. JACKSON BLVD.
CHICAGO, ILLINOIS

Radio Dealers & Servicemen SELL

S. O. S. CINEMAPHONE
16 and 35 m. m. Talking Picture Equipment

Free Literature! may also be ideally used for Public Address

S. O. S. CORP. 1600 B'way., N. Y. C.

LES Correspondence Courses in **RADIO and ELECTRICAL ENGINEERING**

ELECTRICAL ENGINEERING covers complete Most modern course. So simplified anyone can grasp quickly. LOW COST!

RADIO ENGINEERING Ultra-modern course in radio, public address, photo-electric work. Trains you to be super-service man, real vacuum tube technician. Diploma given. Tuition only \$25. either course. Deferred Payment plan.

WRITE TODAY for free copies of school catalogs, student manual, etc. SEND NOW!

LINCOLN ENGINEERING SCHOOL
859 E So. 37th St., Lincoln, Nebr.

A.C.-D.C. MULTIPLE METERS

0-10-100-1,000 VOLTS A.C.
0-1-10-100-1,000 VOLTS D.C.
0-.001-.05-1-10 AMPERES D.C.
0-50,000-5,000,000 OHMS

Precision decimal scale meters for the Service Man, Engineer, Amateur and Experimenter that will never be outlasted by new tubes and circuits. A.C. ranges may be used for output measurements. Beautiful walnut cases. Low price. For details write.

SCHOOLEY ENGINEERING CO., Terril, Iowa

Service Men

New, handy Pocket Tool Case keeps your tools together in a convenient place. Fits in your hip pocket or fastens on your belt. Saves wear and tear on pockets. Have your tools ready when you need them. High grade genuine leather case, double sewed, snap flap. See it at your jobbers. If he cannot supply you write us. Illustrated circular of Radio Service. Also FREE on request.

GENERAL CEMENT MFG. CO.
(Radio Division) Rockford, Illinois

RADIOS..SAVE UP TO 50%

DEAL DIRECT: Factory Price Many models to select from At 1/2 Off. All wave. Parts. Car and new metal Tube Models Your name and address in postcard brings you NEW 16 page 1936 Hertzian Catalog in colors FREE! Get details of 30-DAY TRIAL plan and Agent User Information

Goldentone Radio Co., Dept. 244
8780 Grand River, Detroit, Mich.

Free Catalog

30 DAY TRIAL \$6.98

STOP GUESSING!

Radio service is easy when you know just where to look for the trouble. A CHUCKER trouble-graph and repair-pricer eliminates Guess-work in what is wrong and what to charge. Used by progressive servicemen everywhere. Price 50c post-paid. (No Stamps.)

PAUL G. FREED
Publishing Division R
5053 Baltimore Ave., Philadelphia, Pa.

MEMBERS FORUM

(Continued from page 545)

ferent makes of testers, without finding a dud; and then the set was gone all over again!

This was getting to be a headache—apparently nothing wrong with the set and yet it wouldn't work. Finally the 3-51 tubes were replaced with new ones and the set played perfectly. The old tubes were evidently slightly gassy, not enough to show on the meter but enough to cause inoperation.

G. C. KISER,
Greensboro, N.C.

SERVICE CONDITIONS IN CANADA

RADIO-CRAFT, ORSMA Dept.:

For some time I have followed the progress of your organization in Radio-Craft and I must say that it is doing more to bring the art of radio service up to the standard which is its due than any other that I know. It seems to me that those who are responsible for its inception and accomplishment are deserving of credit which cannot be measured in dollars and cents. (Thank you!—Editor)

In our city we have the usual condition of chaos in the radio service business to such an extent that Service Men are no longer able to cope with the situation. Unfair practices and haphazard methods have undermined the standing of every qualified Service Man until no one knows where he stands.

Your organization appears to offer the only solution to the problem. The majority of the local Service Men have decided to cooperate with each other and set a standard of qualification. It has been unanimously agreed that the ORSMA standard would be required for membership.

I have been delegated to contact you and arrange for membership. Would you be so kind as to furnish to each of the parties listed on the separate sheet enclosed herewith, the required application blank for a full membership in the ORSMA. Also you could include a few extra copies addressed to me for future members.

Thank you in advance.

J. G. SILLAK,
Medicine Hat, Alta.

We know that such a situation has arisen in many communities and believe that Mr. Sillak's solution may be of help to others. (The requested material has been sent.)

NEW YORK SERVICE MEN CHARTERED BY A.F. OF L.

Service Men in the metropolitan area, as well as all over the country, will be pleased to note that N.Y. Service Men have finally been able to gain recognition by the American Federation of Labor. Thus, for the first time in the history of radio service organizations, have Service Men finally been successful in their efforts to form a real and sincere "union" organization.

The organization, known as the "Radio Technicians League" is chartered by the Int'l Brotherhood of Elec. Workers, and their charter number is B-1004. Their membership is comprised exclusively of radio servicing technicians. The aims of this organization are, naturally, to remove the ills which have reacted detrimentally to the welfare of Service Men, and, in general, improve the social and economic status of all member Service Men.

The executive committee includes many dominant figures in the radio servicing fraternity, such as C. S. Weiss, Herbert Leaf, J. T. Bernsley, Bertram M. Freed, D. Bellare, Albert H. Klee, Jos. America, John Weigand, Fred. Von Stange, and Edw. Reuk.

GET YOUR COPY NOW!

VOLUME 2
of the Official
REFRIGERATION SERVICE MANUAL

\$5.00
POSTPAID

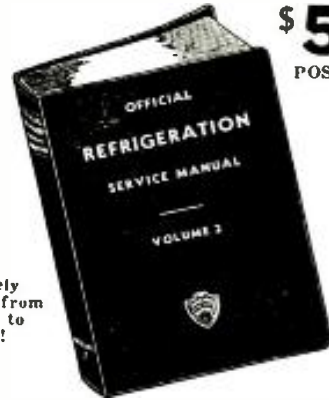

Entirely New from Cover to Cover!

The Only Complete Refrigeration Service Manual Ever Published

The new volume of the OFFICIAL REFRIGERATION SERVICE MANUAL (Volume II) contains entirely new service data and information of value to everyone interested in refrigeration.

This Manual forms a companion and supplement to the previous OFFICIAL REFRIGERATION SERVICE MANUAL (Volume I), since all data in the 1935 volume are entirely new.

The curve of sales of refrigerators and replacement parts has steadily increased year by year—even during depression years. It is the one industry to make this progress. Year by year sales increases will soon place refrigeration in rank with the automobile industry in importance.

Partial Contents in Second Volume of "Official Refrigeration Service Manual"

- Theory and Fundamental Laws
- Methods of Refrigeration
- Refrigerants, Lubricants and Brines
- Handling and Storage of Refrigerants
- Compression System of Refrigeration
- Liquid Throttle Devices
- Refrigeration Systems
- Electric Control Devices
- Compressors, Types, Seals, Valves, Capacities
- Evaporators and Cooling Units
- Service Tools
- Commercial Unit Specifications
- Servicing Refrigeration Apparatus
- Servicing Low Side Float Valve Systems
- Servicing High Side Float Valve Systems
- Servicing Expansion Valve Systems
- Servicing Thermostatic Valve Systems
- Servicing Restrictor and Capillary Tube Systems
- Charging Systems with Refrigerant
- Electrical Service: Motor, Fuses, Hookups
- Estimating Refrigeration Loads

OVER 350 PAGES
OVER 300 DIAGRAMS
Flexible, Looseleaf Binder

This New Refrigeration Manual is printed on a special thick stock. This stock, although unusually thin, is exceptionally strong and durable. It makes handling of the book much easier.

GERNSBACK PUBLICATIONS, INC.
99 HUDSON STREET, NEW YORK, N. Y.

MAIL COUPON TODAY

GERNSBACK PUBLICATIONS, Inc. RC-336
99 Hudson Street, New York, N. Y.
Gentlemen: Enclosed you will find my remittance of \$5.00, for which send me one copy of the OFFICIAL REFRIGERATION SERVICE MANUAL (Volume II). I understand that this book is to be shipped to me POSTAGE PREPAID.

Name
Address
City..... State.....

OVERSEAS READERS!
This book can be obtained from
POWER CONTRACTS, Ltd.
138 Southwark St., London, S.E.1, England

Please Say That You Saw It in RADIO-CRAFT

SPRAYER OUTFIT

ELECTRICAL—PORTABLE

\$32.50 Complete with Gun, ready for Service



This is the ideal outfit for all around spraying work wherever current is available. Sprays everything: Lacquers, Oil, Cold Water Paints, Enamels, Varnish, Insecticides, Disinfectants, Shoe Dyes, etc. The Unit is compact, completely self-contained.

Ideal for spraying Furniture, Radiators, Screens, Machines, and other maintenance paintings in Homes, Schools, Clubs, Hospitals, Stores, Factories, and office Buildings.

The Gun furnished with this Unit is of Pressure Cup type; requires but 2 cu. ft. of Air per minute. Has Bleeder type construction which assures uniform pressure at all times without clogging the Air Passage which is easily cleaned. Furnished with 3 Nozzles which produce Fan, Round, and Right Angle Spray respectively.

Complete Unit consists of Air-cooled Compressor with machined Fan-cooling Pulley, V Belt Drive; Pressure type Gun with 1 quart Aluminum Paint Cup; 3 Tips; 1/2 H.P. Heavy Duty Motor, 110/120 volt, 60 cycle, AC; 15 ft. rubber covered 2 Ply Air Hose; 8 ft. Cord & Plug; Filter Tank; Entire Unit mounted on Base with Ball Bearing Casters.

A low priced Power Sprayer; the kind of Machine that usually sells for \$50.00 to \$60.00.

- Price of complete outfit, shipping weight, 60 lbs. **\$32.50**
- Price of outfit complete, less Motor, shipping weight—35 lbs. **\$25.50**
- Price of Gun only with 3 nozzles, shipping weight, 7 lbs. **\$7.50**
- Price of Compressor only, shipping weight 15 lbs. **\$9.50**

Our Old Customers Know That Our Merchandise Is Sold on a Strict Money-Back Guarantee

All Shipments will be forwarded by Express Collect if not sufficient postage included with your order.

WELLWORTH TRADING CO.

560 W. Washington Bd. Dept. RC-336, Chicago, Ill.

Over 130,000 People Find Each Issue of

EVERYDAY SCIENCE AND MECHANICS of Intense Interest!

EVERYDAY SCIENCE AND MECHANICS is the finest scientific—technical—mechanical constructional magazine in the field. Up-to-the-minute with news flashes of scientific events. Dozens of constructional articles and many popular experiments. Ideas from which you can make things to sell.

A Host of Interesting Subjects Covered:

Woodworking—Photography—Magic—Patents and Inventions—Book Reviews—Metalworking—Chemistry—Engineering—Microscopy—Electrical Experiments—Household Helps—Astronomy—Prize Contests—and other subjects.

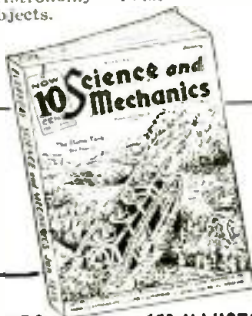

10c
THE COPY

ON ALL NEWSSTANDS

OVER 150 ILLUSTRATIONS

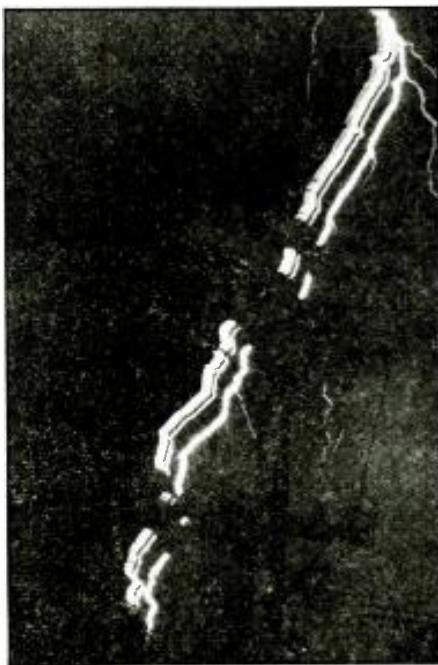

The cloud is usually negative and the earth positive.

DOES LIGHTNING GO UP OR DOWN?

W. W. LEWIS

MANY investigators have worked on the problem of lightning. Some have been interested in the mechanism of its formation and discharge, others in the effects of lightning on transmission lines, buildings, oil tanks, etc. Among those interested in the first phase of the subject may be mentioned N. E. Dorsey of this country, C. T. R. Wilson and Dr. C. G. Simpson of England and Dr. B. F. J. Schonland of South Africa. The G. E. Company, in cooperation with a number of power companies and industries, has been working on the second phase of the subject. The two lines of investigation naturally correlate with and supplement each other.

Dr. Schonland has been working with a camera devised by Professor C. V. Boys of England. This camera has two lenses mounted with their centers 1 ins. apart, carried on a ball bearing axle and revolved at 1,500 r.p.m. The camera pointed at a lightning flash records images on opposite sides of the film by means of the two lenses. During the "lightning seasons" of 1932 and 1933, about 75 pictures were obtained with this camera. It is possible from a study of these pictures, and a knowledge of the direction of motion and speed of the camera, to determine the number of strokes involved in a discharge as well as the direction of the strokes and their speed of propagation. The following general conclusions have been drawn by Dr. Schonland from this investigation:

WHAT LIGHTNING CONSISTS OF

Each lightning discharge usually consists of a number of separate strokes, varying from 1 to 12 or more. The separate strokes follow the same pathway and appear as one stroke on a stationary camera. Each separate stroke consists of a faint downward leader and a heavy upward main stroke. The leaders are formed by darts, averaging about 200 ft. long, traveling at a velocity of approximately 5,000 miles per second, or about 1/10th the speed of light. The main strokes which follow the leaders are thicker, more intense and of decreasing thickness in the upward direction. They travel in the direction from ground to cloud at an average velocity of approximately 25,000 miles per second, or about 1/7th the speed of light. The leader stroke furnishes the preliminary "ionization" necessary for the main breakdown. In these discharges the base of the cloud is negative and the earth positive. Similar results have been obtained in this country by the engineers

Please Say That You Saw It in RADIO-CRAFT

TRY THIS TESTER AT YOUR

JOBBER'S

MODEL 710-A

DEALERS

NET PRICE

Only **\$16.50**

CHECKS ALL PARTS OF RADIO CIRCUITS USING GLASS OR METAL TUBES

This popular three meter set tester checks all parts of radio tube circuits by plugging directly into the receiving set sockets.

- D.C. Voltmeter Scale 20-60-300-600
- D.C. Milliammeter Scale 15-150
- A.C. Voltmeter Scale 10-140-700

Model 710-A—In Black Leatherette Case complete with all necessary connections. Dealer Net Price.....\$16.50

Model 712-A—Same as 710-A but having Triplett moving coil Model 223 2" D.C. Voltmeter (1,000 ohms per volt). Dealer Net Price.....\$22.20

OTHER READRITE PRODUCTS

Readrite also manufactures all types of testers used for servicing radio sets, including: Set Testers, Tube Testers, Oscillators, Resistance, Continuity and Capacity Testers, Point-to-Point Testers and inexpensive Indicating Meters.

Readrite

TESTERS AND METERS

MAIL THIS COUPON

READRITE METER WORKS
316 College St., Bluffton, Ohio

Please send me more information on _____ Model

710-A _____ Model 712-A _____ New Catalogue _____

Name _____

Address _____

City _____ State _____

A new book to add to your technical library
ABC of AIR CONDITIONING
 by Paul D. Harrigan



THOSE who are first becoming interested in the fertile field of Air Conditioning will find in this book all the fundamental principles which underlie the practical systems in use today and written in a way that can be understood by anyone.

The book contains also a step-by-step description of the different types of refrigerating systems, humidifying and de-humidifying methods, air filtering units and heating plants which have been used in Air Conditioning installations, beginning with the invention of artificial cooling and refrigeration and continuing up to the latest types in use today.

The man who wishes to learn about Air Conditioning will do well to start with this comprehensive book.

Brief outline of contents:

- The Future of Air Conditioning
- Uses and Benefits of Air Conditioning
- Elementary Refrigerating Systems
- Types of Winter and Summer Air Conditioning Installations and their Operation
- Service and Control Applied to Air Conditioning Systems
- Ventilation Data for Air Conditioning
- Definitions Used in Air Conditioning
- Air Conditioning Books

Send fifty cents in stamps, money order or coin for your copy of the ABC of Air Conditioning—it is sent postpaid upon receipt of your remittance.

GERNSBACK PUBLICATIONS, Inc.
 99R Hudson Street New York, N. Y.

Size—6x9 Inches
 64 Pages
 Stiff, flexible covers

It has been shown in the laboratory, working with small-scale models of cloud and earth, that if the cloud is positive a rod projecting above the earth will protect an area around the rod with a radius about twice the height of the rod, i.e., a stroke from the cloud will either hit the rod or hit the ground outside the protected area.

However, if the cloud is negative (and the rod positive), the protected area will have a radius 10 to 12 times the height of the rod, i.e., all of the strokes from or to clouds directly overhead will terminate on the rod and none on the earth.

PROBABILITY OF STRIKES

In terms of the mechanism previously described, with the cloud negative and the rod positive, the discharge starts at the rod and proceeds upward, i.e., the discharge is directed by the rod and, hence, necessarily terminates on the rod. However, with the cloud positive and the rod negative, there is only a 50-50 chance of the stroke terminating on the rod. On transmission lines the towers and overhead ground wires direct the strokes and act as their terminals. Over houses and barns lightning rods perform this function and in fields of oil tanks, tall masts or poles are used. To be most effective, however, in achieving protection the overhead ground wire, tower, lightning rod, etc., must be well grounded, i.e., connected to earth through low resistance.

"FINGERPRINTING" THOR

Going back now to the matter of successive strokes: Dr. Schonland's observations in this respect have been checked in a number of ways, e.g., photographs of lightning have been taken with a single-lens camera which has been moved slightly. The resulting photographs have shown a spreading or fanning out of the stroke into a number of strokes, apparently identical in shape. For the same discharge a picture obtained with a stationary camera apparently shows only one stroke. Other photographs with a stationary camera have shown the stroke apparently fanned out by the wind, giving a lacy or gauzy effect.

Further confirmation of the successive stroke theory has been obtained by means of a high-speed magnetic oscillograph on the Appalachian Electric Power Company's power system. On this system the insulator strings are shunted by expulsion protective gaps. On the occurrence of a lightning stroke the gaps discharge and pass power current to ground for 1/2-cycle. The oscillograph shows these gaps operating repeatedly on the occurrence of a lightning discharge, indicating in different cases as many as 2 to 8 successive strokes consuming a total time of from 1/20th to 1/2-second.

Thus as a result of the work of investigators in various parts of the world, our knowledge of lightning is becoming more complete and among the things that appear to be demonstrated are that a discharge between cloud and earth occurs in a number of successive strokes over the same pathway; and that usually each stroke consists of a faint downward "leader," which ionizes the path for the main upward stroke, the latter carrying the current and the greater part of the luminosity. Engineers combining this knowledge with that obtained from laboratory investigations and field investigations on transmission lines are able to work out a practical means of protecting transmission lines and stations, buildings, etc. from the destructive effects of lightning.

This article has been prepared from data supplied by courtesy of General Electric Co.

By moving the camera the many individual discharges can be seen, fanned out.

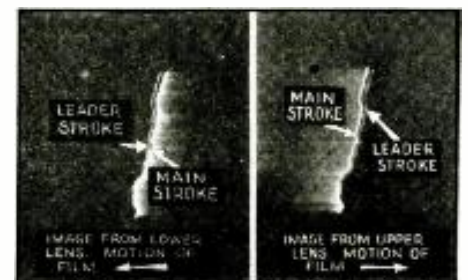

Westinghouse Power Generator

Manufactured for U. S. Signal Corps
 200 Watt. 110 V. AC

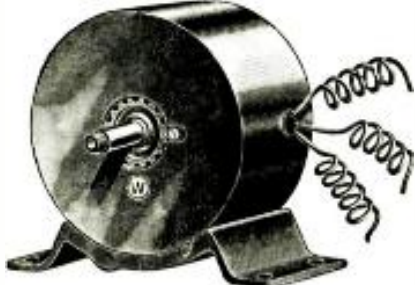

A. C. ELECTRICAL POWER

from a Windmill, from available Waterpower, from your Automobile, from your Motorcycle, from your Bicycle, Foot-pedals or Handcrank (for transportable Radio Transmitters, Strong Floodlights, Advertising Signs); do you want to operate AC Radio sets from 32 V. DC farm light systems; operate two generators in series to get 200 V. AC; obtain two phase and three phase AC, etc., etc.

There Are Over 25 Applications
 Some of which are:

A.C. Dynamo lighting from eight to ten 20 Watt 110 Volt lamps, Short Wave Transmitter supplying 110 Volts AC for operating "Luna" transmitter, Operating 110 V. AC 60 Cycle Radio Receiver in DC districts, Motor Generator, Public Address Systems, Electric Signs on motor boats, yachts, etc. Camp Lighting, Short Wave artificial "Fever" apparatus, Television, Pelton Waterwheel for lighting or other purposes, Airplane for lighting strong search lights or electric signs, Laboratory work, etc., etc. 1/4 to 1/2 H.P. needed to run generator.

BLUE-PRINT 22x28 in. and Four-Page 8 1/2 x 12 in. INSTRUCTION SHEETS FREE WITH GENERATOR.

Generator, as described, including four replacement carbon brushes. Blue-Print and Instructions **\$7.90**

Send \$2.00 deposit balance C.O.D. Shipping weight 18 lbs.

(Replacement carbon brushes bought separate \$1.50 per set of four. Set of instructions bought separate \$1.00.)

MONEY-BACK GUARANTEE

WELLWORTH TRADING COMPANY

560 West Washington Blvd., Dept RC336, Chicago, Illinois

of the G. E. Company with a modified "Boys" camera, in which the lenses are stationary and the film is mounted on the inside of a drum and revolved at about 3,000 r.p.m.

Field work on transmission lines has been conducted to determine the magnitude and polarity of current in transmission towers caused by lightning. The records are obtained by means of small Cobalt-steel magnetic links mounted adjacent to the tower legs. When current passes through the tower the links become permanently magnetized in proportion to the amplitude of the current and the distance of the link from the angle-iron forming the leg. The magnitude of the current and its polarity are determined by means of an instrument called a surge crest ammeter.

During the years 1933 and 1934 approximately 300 readings were obtained, ranging from 4,000 amperes to 83,000 amperes in a single tower, and up to a total of 167,000 amperes in a stroke, simultaneously affecting 8 towers. In order to visualize this amount of current it may be noted that a 60-watt lamp draws about 1/2-ampere, a flat-iron 3 to 5 amperes, etc. But, of course, the lightning current passes very quickly—in a few hundred micro-seconds (millionths of a second); whereas, the lamp or flat iron may be drawing current for an hour or more.

POLARITY AND DIRECTION

Of the 300 records obtained with the magnetic links in the manner described, all but 6 indicated negative polarity, i.e., the top of the tower was negative with respect to ground. This is interpreted in view of the known behavior of electricity in the laboratory as indicating that the cloud is negative and the earth positive; and that the current travels upward in the tower from bottom to top, and from tower-top to cloud. These results as to polarity and direction of current flow confirm those obtained by Dr. Schonland by means of the revolving lens camera.

SCIENTIFIC LIGHTNING PROTECTION

The significance of this mechanism, if it has been correctly interpreted, lies in the fact that it explains many phenomena not thoroughly understood and points the way to adequate protection of transmission lines, buildings, oil tanks, etc., from lightning.

Please Say That You Saw It in RADIO-CRAFT

Something NEW!

WEATHER FORECASTER AND HUMIDITY TESTER

"HYGROSCOPE"

The Ace of Weather Forecasters



When placed in a well-ventilated room or in the fresh air, the HYGROSCOPE foretells coming weather conditions from eight to twenty-four hours in advance. It also accurately records outdoor humidity, and when placed inside it gives the humidity within the house or room.

The HYGROSCOPE is automatic self-adjustable, simple American-precision made. It cannot get out of order at any time. The dial measures 2 3/4" and is enclosed in a 6" round hard wood case, with either walnut or mahogany finish. It is attractive for desk or living room.

OUTSIDE DIAL FORECASTS WEATHER

Fair—rain—or changeable is indicated on the outer dial when the HYGROSCOPE is placed in a well-ventilated room or out-of-doors. If indoors, place the instrument near an open window.

INNER DIAL SHOWS THE HUMIDITY CONTENT

The HYGROSCOPE also acts as a hygrometer. Numbers on the inner dial indicate the degree of humidity present in the air and in artificially heated rooms.

SEND YOUR ORDER NOW! Get your HYGROSCOPE today. Your remittance in form of check or money order accepted. If you send cash or unused U. S. Postage Stamps, be sure to register your letter. Also specify if you prefer the HYGROSCOPE in Walnut or Mahogany. **\$2.00**

Postpaid

GREN PARK COMPANY

Dept. RC-336

99 Hudson St. - New York, N. Y.

-- a new magazine for short-wave fans! **SHORT WAVE LISTENER**

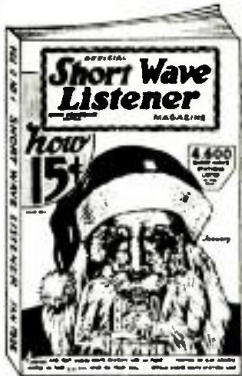

4,600 Short Wave stations listed

THE finest magazine of its kind ever published—totally different in get-up and contents from any other. Contains the largest listing of short wave stations in the world, up-to-the-minute, including "Police," "Television" and short-wave stations, as well as a special list of the star short-wave stations with their frequencies and call letters. Also contains photos and descriptions of short-wave broadcasting stations in various parts of the world with photos of short-wave studio aerials—How to locate "weak" distant stations and other hints for the "short-wave listener"—Question and Answer Department for the "listener"—Silver Cup Trophy for best photo of listening "Post."

NOW 15c the Copy ON ALL NEWSSTANDS **SHORT WAVE LISTENER** 99 Hudson St. New York, N. Y.

CLASSIFIED ADVERTISEMENTS

Advertisements in this section are inserted at the cost of twelve cents per word for each insertion—name, initials and address each count as one word. Cash should accompany all classified advertisements unless billed by a recognized advertising agency. No less than ten words are accepted. Advertising for the April, 1936, issue should be received not later than February 6, 1936.

A.C. AUTO GENERATORS

TURN SCRAP INTO MONEY. AUTOPOWER SHOWS you how easily and economically auto generators can be converted into A. C. or D. C. generators and D. C. motors, 2 to 1000 volts; for sound, radio, power, light, or welding. No previous experience necessary—complete information all in new book, with simple instructions and illustrations. Endorsed by thousands. Only \$1.00 postpaid. Autopower, Inc., 411-C S. Hoyne Ave., Chicago.

RADIO

RADIO ENGINEERING, BROADCASTING, AVIATION and police radio, servicing, Marine and Morse Telegraphy taught thoroughly. All expenses low. Catalog free. Dodge's Institute, Pine Street, Valparaiso, Indiana.

SOME FACTS ABOUT ALL-WAVE NOISE-REDUCING AERIALS

ONE principle which has been successfully employed for the reduction of man-made static is to locate the antenna in a comparatively noise-free area and to employ a lead-in of such a type that pick-up on the lead-in is eliminated. However, the type of lead-in is an important design problem. There are two general types—the shielded lead-in and the balanced transposed line. The shielded line is unsuitable for high frequencies, because to be effective, the shielding must be grounded every few feet with short ground wires, which is, of course, impractical.

The balanced line, however, is eminently suitable for many reasons. When used in conjunction with a well-designed transformer at the set, pick-up on the line is almost completely eliminated. No grounding is necessary. Losses are lower than in a shielded line and are negligible if the design is right.

In designing the line, the space between the wires and the size of the wires are important. The farther apart they are, and the smaller they are, the higher is the characteristic impedance of the line. If a line is terminated at each end with its characteristic impedance, its transmission is nearly constant at all frequencies. However, when the terminating impedances are widely different from the proper value, the transmission varies greatly with frequency.

It is well known that a half-wave doublet is a most efficient collector of short-wave signals. However, it is at its best only at or near its resonance point. Obviously, if 2 dissimilar doublets can be connected to the same transmission line without either harming the performance of the other, the overall performance of the combination will be good over a wider range than a single doublet.

The secret is the much-discussed "cross-connection." That is, the left arm on the longer doublet connects to the same side of the transmission line as the right arm on the short doublet. The connection must be made in this way in order for the output of the short doublet to be additive to the output of the long doublet at a frequency midway between their resonance points.

The long doublet is resonant in the half-wave mode at about 8 mc. and in the 3/2 mode at 24 mc. The short doublet is resonant at about 14 mc. The response of the combination is relatively flat over the important part of the short-wave spectrum.

It is very important to note that the noise-eliminating feature of the system depends entirely on the design of the transformer which couples the line to the set. The purpose of this transformer is to eliminate "in-phase" signals while transmitting "out-of-phase" signals. The expression "in-phase" means that the voltages of the 2 sides of the line go positive together and then go negative together. Obviously, this type of signal will produce no current in the primary of the transformer, it simply changes its potential.

"Out-of-phase" signals are those which cause one side of the line to get negative when the other goes positive and then the reverse. This type of signal does produce primary current.

In the transformer under discussion a special and highly efficient static shield is used, completely eliminating capacity coupling. As a result, the "in-phase" signals and noise picked up by the line are eliminated while the "out-of-phase" signals picked up by the antenna are transmitted to the receiver.

The circuit diagram of the complete antenna system is shown in Fig. 1. When the switch is at position marked "S.W.," operation is as described above. When the switch is on "STD" position the antenna and lead-in both act as an ordinary antenna.

This article has been prepared from data supplied by courtesy of RCA Manufacturing Co., Inc.

Fig. 1. The circuit of the antenna system.

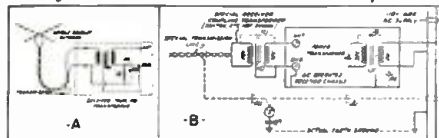

Sears

Lead in Radio Parts and P. A. System Values



15-24 WATT AMPLIFIER

\$27²⁵ CASH
Sold On Easy Terms
\$6⁵⁰ DOWN

- 6B5 Class A Power Amplification.
- Uses Carbon or Crystal Mike without Pre-amplification.
- Master Tone Control.
- Automatic Impedance Matching for one or two speakers.
- Plug-In Connections for quick set ups.
- Built-in 20 Watts Field Supply and Mike Transformer—no extras to buy.

This is but one of the three thousand outstanding Bargains Sears offer you in our Radio Parts Catalog. Sears carry a complete line of amplifiers, P.A. systems and Associate equipment; a wide selection of the very latest Testing Equipment for servicing either metal or glass tube equipped radio receivers. Also a comprehensive selection of condensers, coils, transformers, resistors, etc., for Radio Servicemen, Amateurs and Experimenters. Hundreds of new, and interesting gadgets and accessories for repairing old sets or building new ones. All priced to save you money and all backed by Sears iron clad guarantee of satisfaction with every purchase.



FREE

68 Page Catalog of Radio Supplies, P. A. Equipment and Amateur needs, of which many items can be bought on

EASY TERMS

RUSH THIS COUPON TO US FOR OUR NEW CATALOG—SAVE UP TO 50% on RADIO SUPPLIES

Sears, Roebuck and Co., Homan and Arthington Sts., Chicago, Ill.

Please send me your new 1936 catalog, L 653RC, of Radio Parts and Supplies.

Name _____
Address _____
City _____ State _____

SERVICEMEN

Look up October RADIO-CRAFT page 215

SERVICE OSCILLATOR

SAVE \$15.00 on this ALL-WAVE SERVICE OSCILLATOR ALL GENUINE PARTS FURNISHED AT LOWER THAN WHOLESALE PRICES



BLAN THE RADIO MAN, Inc. Headquarters for Parts—Since 1923 A177 Greenwich St., New York, N. Y. NO CATALOGUE—BUT LOWEST PRICES

Please Say That You Saw It in RADIO-CRAFT

Cut Prices on Many Popular Radio Books

IMPORTANT—All prices have been drastically reduced—many new books included!

We herewith present a selected collection of recent important radio books. We have, after an exhaustive study, selected these volumes because they represent the foremost radio books of their kind in print today. There is such a great variety that we are sure it will satisfy any taste as well as any requirement that the student of radio might have.

We publish no catalog and ask you to be kind enough to order direct from this page. Prompt shipments will be made to you direct from the publishers. We merely act as a clearing house for a number of radio publishers and **OUR PRICES ARE AS LOW OR LOWER THAN WILL BE FOUND ANYWHERE.** Remit by money order or certified check. Register all cash.

SHORT WAVES, by C. R. Leutz and R. B. Gable. Stiff Covers. Size 6x9", 384 pages, 258 Illustrations. Price was formerly \$2.98. **NEW PRICE NOW, \$1.15** prepaid.

The biggest and most complete book on short waves. Covers every imaginable phase. Including S. W. Superheterodynes, Television, Aircraft Radio, Ultra Short Waves, Directional Antennae, etc. The authors are famous short-wave authorities. This is the best book on Short-Waves in print today.

PRACTICAL TELEVISION, by E. T. Lamer. Cloth covers, size 5½x8½", 223 pages, 127 Illustrations. Price..... **\$3.69**

This book explains television in full, including elementary principles, photo-electric cells, and all important types of television sets as well as basic principles of optics, images, mirrors, lenses, etc.

ELEMENTS OF RADIO COMMUNICATION (Second Edition), by John H. Morecraft. Cloth covers, size 6 x 9½", 286 pages, 241 Illustrations. **\$2.98**

An introductory volume, written in easily understandable style, to the more comprehensive, "Principles of Radio Communication."

OFFICIAL SHORT-WAVE RADIO MANUAL, Volume 1, by Hugo Gernsback and H. W. Secor, with 352 pages, Illustrations, Flexible, Looseleaf Leatherette Binder, Size 9x12", Price **\$2.00** Prepaid.

The one and only short-wave manual published. Contains constructional information on the most important Short-Wave Receivers, sections on S.W. Transmitters, Ultra Short Waves, S.W. Beginner's section, coil winding, A.C.-S.W. Power Packs, kinks, etc., for S.W. Experimenters, sections on S.W. Converters, Antennae, Superheterodynes, Amateur Phone Transmitters, Super Regeneration in S.W. Receivers, S.W. Therapy, S.W. Physics, etc.

SHORT WAVE WIRELESS COMMUNICATION, by A. W. Laidner and C. R. Stoner. Cloth covers, size 6x9", 348 pages, 200 Illustrations, 12 plates. **\$3.46**

Short wave experimenters who have grown out of 1-tube sets will revel in this book, which tells the "how come" of short-wave operation. A good portion of the volume is devoted to the amateur and commercial aspects of S. W. transmission.

THE RADIO AMATEUR'S HANDBOOK, (New Revised Edition), by A. Frederick Collins. Cloth covers, size 5½x7¾", 394 pages, 116 Illustrations, **\$1.97**

If you wish to become a radio amateur (radio ham) this book tells you how. Everything in receiving and transmitter sets and how to build them.

RADIO THEORY AND OPERATING, by M. T. Loomis, 5th revised Edition. Cloth-bound; size 5½x8½" thick; 1,000 pages; over 800 illus.; 450 review questions and answers. **\$4.38**

Written in textbook style, a tremendous amount of useful information has been crammed into this thin-paper, compact reference work. Radio transmission and reception have been covered, "from soup to nuts." A truly great book.

MODERN RADIO ESSENTIALS, by Kenneth A. Hathaway. Cloth covers, size 8½x5¾", over 200 pages, and over 100 Illustrations. Price..... **\$1.95**

NEW! Unlike most books dealing with radio fundamentals, Hathaway's new book is arranged for quick use by the practical technician. In addition, it brings the reader right up-to-date on essential radio theory.

RADIO RECEIVING TUBES, by Mover and Westrel. Cloth covers, size 7½x5½", 298 pages, 181 Illustrations. **\$2.47**

One of the finest books on vacuum tubes. Everything worthwhile on the subject treated in a masterful manner.

PHOTOCELLS AND THEIR APPLICATION, (Second Edition), by V. K. Zworykin and E. D. Wilson. Cloth covers, size 5½x8", 332 pages, 180 Illustrations. Price..... **\$2.88**

Does this book tell you why and how to use light-sensitive cells? The answer is that the first edition was a "sell out," and the second edition, brought right up to date, is even a better volume. Enough said.

ELECTRONICS, by R. C. Hudson. Cloth covers, size 6x9", 134 pages, 45 Illustrations. **\$1.95**

"This book is written for the reader who may wish to know something about what is going on and who has not heretofore given the matter much attention," says the author. Read it and learn how dry rectifiers, vacuum tubes, batteries, television tubes, and other apparatus, work; get the "low down" on electrons and atoms.

SHORT WAVE RADIO HANDBOOK, by Clifford E. Denton. Paper covers, size 6½x8½", 128 pages, 150 Illustrations. **\$1.00**

Coil data, circuit data, testing data, I.F. and A.F. amplifier data—in fact, let us say, "data of every imaginable sort—in connection with short-wave radio reception."

PRINCIPLES OF RADIO, by Keith Henney, M. A. Cloth covers, size 8x5½", 478 pages, 306 Illustrations. Price..... **\$3.46**

A marvelously written textbook with the latest radio principles, including screen grid and pentode, amplifiers, etc.

HOW TO ORDER
We cannot ship C.O.D. Our prices are net, as shown. Some of the books sent prepaid (in U. S. only). Those that are not thus listed will be shipped by express collect if sufficient postage is not included by you.

NEW LOW PRICE RADIO BOOKS

- Here are new, up-to-date books on every conceivable radio subject, just published. Modern in every sense. ALL BOOKS UNIFORM from 61 to 72 pages; 50 to 120 illustrations. All books written by well-known radio authors.
- HOW TO BECOME AN AMATEUR RADIO OPERATOR..... **45c**
- HOW TO GET BEST SHORT-WAVE RECEPTION..... **45c**
- 101 SHORT-WAVE HOOK-UPS..... **45c**
- HOW TO BUILD AND OPERATE SHORT-WAVE RECEIVERS..... **45c**
- THE SHORT-WAVE BEGINNER'S BOOK..... **25c**
- 10 MOST POPULAR SHORT-WAVE RECEIVERS AND HOW TO BUILD THEM..... **25c**
- SHORT-WAVE COIL BOOK..... **25c**
- HOW TO BUILD FOUR DOERLE SHORT-WAVE SETS..... **10c**
- HOW TO MAKE THE MOST POPULAR ALL-WAVE 1-2-TUBE RECEIVERS..... **10c**

RADIO PUBLICATIONS 99A HUDSON STREET NEW YORK, N. Y.

THIS MAGAZINE NEEDS NO INTRODUCTION TO SHORT-WAVE FANS

SHORT WAVE CRAFT

This popular monthly magazine, **SHORT WAVE CRAFT**, contains everything you want to know about Short Waves. The wonders of world-wide short-wave reception are clearly described and illustrated. Latest practical information for radio fans, experimenters and "hams" will be found. Tells you how to build short-wave receivers and transmitters; construct sets of one and two tubes or as many as seven, eight or more. Tells best foreign stations to log and when to tune them—in-tunes news; and best circuits of the time. **SHORT WAVE CRAFT** is edited by Hugo Gernsback.

NEW FEATURE RECENTLY ADDED—To the short wave fan who has logged and obtained verification of the largest number of short-wave stations from all over the world during one month, will be awarded a magnificent 24" silver trophy.

Special This Month Only!
For the month of February only, we offer readers of this magazine the opportunity to read radio's greatest short-wave magazine at a special saving. The regular subscription price is \$2.50 per year. You can now get **SHORT WAVE CRAFT** for the next

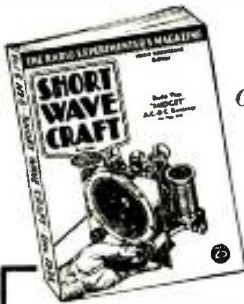

8 MONTHS FOR \$1.00
4-Color Cover
Over 200 illustrations
9x12 inches in size
25c The Copy
ON ALL NEWSSTANDS

Send remittance by check, money order or U.S. Postage Stamps. Register letter if it contains cash or currency.
SHORT WAVE CRAFT
99R Hudson St. New York, N. Y.

OPERATING NOTES (MISCELLANEOUS)
(Continued from page 548)

Philco Model 38 Radio. In one week's time I had 15 model 38 Philco's on the work bench. All the sets had the same trouble, completely dead or intermittent operation. After checking all the sets over they tested OK in every respect, but still they would not play.

The correct procedure to remedy this trouble is as follows: remove the original cathode resistor (6,000 ohms) and replace it with a 2,000 or 3,000 ohm resistor. Nine chances out of 10 this will correct the trouble. In the more obstinate cases remove the oscillator coil and boil it in paraffin, as this is a sure cure.

H. T. BAILEY

A K. 636 Auto Set. The set was satisfactory while the car was motionless or even with the motor running, but when the car was pulling, regardless of its speed, a very noticeable flutter appeared. This disappeared the moment the accelerator was released.

With one of the Type 41 tubes in the analyzer, the car was put in motion, and we noticed the voltage fluctuate with the motion of the car, and exactly in time with the flutter of the signal. Upon removing the "B" unit, which is a motor-generator, we found that the commutator on the generator side had a high spot, which, with the vibration of the car when pulling, was causing the trouble. Turning down the commutator (and it is also a good idea to turn down the commutator on the motor side while the unit is out) cured the trouble.

J. C. WHITNEY

Gloritone 26. This set would play quite well for a while then suddenly and quietly it would completely cut out. When cut out, the 2,640 ohm resistor would heat up to the boiling point in a few seconds. This resistor was originally a candohm, but out of 4 of these sets, 3 had the candohm replaced with a carbon-type resistor.

After searching over the set for a couple

of hours, the trouble was found in the speaker field, which is tapped to act as a bleeder to supply the screen-grid voltages. When it shorts, it shorts across the hot side to ground through the above-noted resistor; hence the heat. The short can be proved by connecting a voltmeter (330 V.) from the red wire to the white wire of the speaker. If shorted, this will drop to zero when the set cuts out. The speaker is easy to dismantle and after taking off the paper cover of the field, it will be seen that some of the insulation is worn from the enameled wire under a lead connection. Placing a piece of heavy paper or cambric under the soldered connections of the leads will cure the trouble. It is better to dope the coil and re-cover it. The resistor must be replaced for it is sure to be damaged.

Philco 80. This set has frequent trouble with noisy volume controls which seem almost impossible to fix without a more or less costly replacement. The carbon strip is curved so that with the riveted contact arm over it, there is little possibility of using the old "pencil eraser" cure. However it will be noted that the end of the contact arm is a tiny disc with a hole in which a tongue from the arm is snapped. By raising the arm a trifle, this disc slips out and may be turned over. A few turns of the arm with this disc reversed will cure most of the trouble. What remains may be removed by rubbing the carbon strip with a piece of hard-finish paper over the end of a screwdriver. Leave the disc in the new position. While you are at the set, check the condenser from ling to chassis. Quite often this is a trifle leaky and can cause trouble. (This method of resistor repair can be applied to other sets, as quite a few use the type of volume control described above.—Editor)

Grunow 501. It was found that set would still draw current with the switch off. The dial lights would glow slightly as an indication. The trouble was found in the fairly large condenser jammed in behind the speaker. Replace with a smaller size unit.

Please Say That You Saw It in RADIO-CRAFT

NEW Dependable Test Equipment

Dependable TUBE CHECKER Model 305

Takes all glass and metal tubes and roaming filaments. 5" fan-type, full view, "Good-Bad" meter scale. Simple to operate. No adapters required.



Ready to Operate: \$21.95

Kit: \$17.85

In addition to testing all tubes, this efficient instrument tests shorts and leakages above 500,000 ohms with neon light. Makes capacity and ohmmeter tests. Tests all types of condensers. Has separate line voltage meter. EFFICIENT—CONVENIENT—HANDSOME—LOW PRICED.

Dependable ANALYZER Model 6123



You need this up-to-the-minute business-building Model 6123 Analyzer. Moving coil meter, accurate within 2%, 2,000 ohms per volt sensitivity. Sockets for metal and all other tubes. Self contained 3-range ohmmeter, 1-range voltmeter. Automatic selector switches with spare points. 11-wire analyzer cable with prods. Independent metering system. "Sure Pull Out" plug adapters. Complete, ready-to-use. \$21.95 NET

Dependable POWER LEVEL INDICATOR Model 421



Complete: \$25.85—Kit: \$21.00

Important help for P.A. men. Measures power levels from 12 to plus 13 decibels. Highly accurate 5" fan-type meter calibrated from down 12 to up 19 decibels. 500 micro amp. movement. Knife-edge pointer. Unique 10,000 ohm constant impedance 1-type attenuator. Also direct-reading, 4-range A.C. voltmeter for all frequencies.

We Issue No Catalog All orders are P.O.B. New York. Terms: A deposit of 20% is required with every order. Balance may be paid on delivery. DEDUCT 2% IF FULL AMOUNT IS SENT.

GRENPARK COMPANY
101 Hudson St. Dept. RC New York, N. Y.

Silvertone 41. This receiver, sometimes listed as Model 1152, is beginning to have numerous failures of condensers, particularly in the bank on the front, power-pack side of the chassis. Be sure to check all of these and replace if possible; this may save your reputation. One of these sets came in with the field of the speaker open. The speaker has a 1,450 ohm field which acts as the bias resistor. The open was located, as most such are, in the soldered joint under the speaker-field winding cover. Don't try to take the speaker apart, for it won't come. The cover, however, can be worked loose, and around, enough to make the repair.

Ford-Majestic 40. The fuse clips on this set are apt to work loose, thus stopping the set. Use a drop of solder or a wedge of some sort. Note that there are two fuses, supplying different parts of the set, but both in the "hot" lead.

The set will work much better if the variable condenser bank and the vibrator unit shield are bonded more completely to the rest of the chassis.

A rubber band placed lightly around the voice-coil lead wires will take out a rasping rattle when the volume is turned up.

A few ventilation holes drilled so as to cool the area under the vibrator unit will add to the life of the condensers located there. Shellac some loose woven cloth over the holes to keep out dust.

MAURICE ALEXANDER

King Models 94 and 98. Several complaints have been received on King receivers—models 94 and 98. The complaints concerned distortion in the form of fuzzy notes. This is usually due to an open choke in the first stage connecting the grid to the ground. This choke provides the grid bias voltage for the first R.F. tube. With the choke open, the tube acts like a detector due to the lack of bias.

HAROLD MILLER

Special Notice to Radio-Craft Contributors.

"Replacing the second-stage A.F. tube cleared the trouble." How many times have you had Service Men tell you that some such procedure solved a service problem? But this "information" is hardly instructive—what the practical man wants to know is **WHAT WAS THE ACTUAL REASON WITHIN THE SET** that caused the receiver to cease functioning properly. Perhaps an off-value resistor or condenser is causing excessive voltages to be applied to certain elements of one or more tubes. Note that faults which may be attributed to defective tubes are not to be considered as "legitimate" Operating Notes, and should not be submitted to this department for publication. Also—and this is especially important—only those items that have been observed repeatedly, for a particular set model, should serve as Operating Notes.

"MULTIPLE-IMAGE TELEVISION RECEIVER"—(A Comment)

In a letter to *Radio-Craft*, Mr. Canio Maggio of Brooklyn, N.Y., calls attention to a similarity existing between a multiple-image television device which he described in the November and December, 1931 issues of *Television News* (no longer printed), and the article by Mr. Hugo Gernsback in August, 1935 *Radio-Craft*, pg. 74.

This is very interesting information which we are glad to bring to the attention of television experimenters. It is to be noted however that whereas Mr. Maggio has recourse to a reflection method, Mr. Gernsback has utilized a direct-projection scheme utilizing mechanisms that were not available to the earlier experimenter.

MAGIC

My radio has a "Magic Brain,"
It says so in the ad,
It also has a "Magic Eye,"
Which old sets never had:
And yet it gets the same old things,
Those guys who croon or shout:
If I but had a "Magic Foot" . . .
I'd kick the whole works out!

LATHAM OVENS.
Reprinted from N. Y. Sun.

Train Now for New RADIO Opportunities



Get Into a Line Where There's Action—Every Day—And a Payday Every Week—You Be the Boss!

Analyzer & Resistance Tester—Latest Design—YOURS Without Extra Cost

Right now while hundreds are looking for work where there isn't any, the radio service field can use trained men. With the proper training and the necessary equipment, you can enter this field and make a comfortable living. We include with our course this modern set analyzer and trouble shooter without any extra charge. This piece of equipment has proved to be a valuable help to our members. After a brief period of training you can take the set analyzer out on service calls and really compete with "old timers." We show you how to wire shortwave receivers—analyze and repair all types of radio sets and many other profitable jobs can be yours. Teaching you this interesting work is our business and we have provided ourselves with every facility to help you learn quickly yet thoroughly. If you possess average intelligence and the desire to make real progress on your own merits, you will be interested.

ACT NOW—MAIL COUPON

Start this very minute! Send for full details of our plan and free booklet that explains how easily you can now cash in on radio quickly. Don't put it off! Write today. **SEND NOW!**

RADIO TRAINING ASSN. OF AMERICA
Dept. RC-63, 4513 Ravenswood Ave., Chicago, Ill.

Gentlemen: Send me details of your Enrollment Plan and information on how to learn to make real money in radio quick.

Name.....

Address.....

City.....State.....

UP IN A JIFFY AT ANY ANGLE

RCA RK-40 All-Wave Antenna \$5.50



It's simple to install. Goes up in a few minutes, at any angle, wherever you can put a 60-foot straight wire. Gets more stations on both broadcasting and short wave bands. A really fine antenna that will be especially valuable in difficult locations. Factory assembled, all joints soldered. Get it from your RCA Parts Distributor.

RCA Mfg. Co., Inc., Camden, N. J.
A subsidiary of the
RADIO CORPORATION OF AMERICA



ANTENNA SYSTEMS

Please Say That You Saw It in RADIO-CRAFT

Special Announcement

To-date we have issued the following publications of vital importance to service men:

1931 Official Radio Service Manual

1932 Official Radio Service Manual

1933 Official Radio Service Manual

1934 Official Radio Service Manual

1935 Official Radio Service Manual

Official Auto-Radio Service Manual (Vol. No. 1)

Official Auto-Radio Service Manual (Vol. No. 2)

Every Service Man, in order to be properly equipped to service the older sets, which naturally cause the most trouble, should have the complete set of these manuals. With this end in view we are desirous of making a special proposition to anyone who has some of these manuals but not the complete set.

If you will be good enough to fill in the coupon appearing below, and mail it to us, we will make you a proposition to enable you to fill in the missing manuals and pay for them on an installment proposition.

**MAIL
COUPON
TODAY!**

Gernsback
PUBLICATIONS,
INCORPORATED

99 HUDSON ST. NEW YORK, N.Y.

Gernsback Publications, Inc. RC-336
99 Hudson St., New York, N. Y.

I now own the following manuals (check the one you now have).

- 1931 Official Radio Service Manual
- 1932 Official Radio Service Manual
- 1933 Official Radio Service Manual
- 1934 Official Radio Service Manual
- 1935 Official Radio Service Manual
- Official Auto-Radio Service Manual (Vol. No. 1)
- Official Auto-Radio Service Manual (Vol. No. 2)

Will you kindly mail me a special proposition whereby I may secure the missing ones. It is distinctly understood that the sending of this coupon does not obligate me in anyway.

Name

Address

City State

Please Say That You Saw It in RADIO-CRAFT

BOOK REVIEW

A 2-BOOK RADIO "LIBRARY"

An interesting idea in radio literature is the 2-book "set" recently written by A. A. Ghirardi; Bertram M. Freed collaborated in the preparation of the smaller of the two books. Both books are published by Radio and Technical Publishing Co. More detailed information follows.

RADIO FIELD SERVICE DATA. Size 5½ x 8 ins., 41 illustrations, 240 pages. Price \$1.50.

This supplement to "Modern Radio Servicing," contains a great amount of useful information, many tables, and the answers to the questions which are found in the larger book. The table of radio set intermediate frequencies covers 2,790 models of 137 manufacturers. A condensed list is given of the most common troubles in 750 different sets. There is a great amount of priceless material on auto-radio installation, including noise elimination for various cars, and wiring diagrams for 36 cars.

MODERN RADIO SERVICING. Size 6 x 8½ ins., 706 illustrations, 1,300 pages. 723 review questions. Price, \$4.00.

Completely revised and enlarged (1935), this volume is recommended to readers as "a practical text on the theory, construction and use of modern radio service equipment and the rapid and systematic methods of radio servicing in all its branches," as the author planned.

An outstanding characteristic of the book is the care with which the technical data has been culled from the mass of irrelevant material that all too often detracts from the possible worth of many modern radio books.

The book is divided into 4 parts, as follows:
 Part I. 1. Introduction. 2. Milliammeters, Ammeters and Voltmeters. 3. Methods and Instruments for Measuring Resistance. 4. How to Construct Ohmmeters. 5. Typical Commercial Ohmmeters. 6. Condenser Testers and Capacity Meters. 7. Output Meters and V.-T. Voltmeters. 8. The Tube Checker. 9. How to Construct A Modern Tube Checker. 10. Typical Commercial Tube Checkers. 11. The Voltage-Current Set Analyzer. 12. Point-to-point Testing. 13. How to Construct a Complete Set Analyzer. 14. Typical Commercial Set Analyzers. 15. The Service Test Oscillator. 16. How to Construct and Calibrate a Test Oscillator. 17. Typical Commercial Test Oscillators.

Part II. 18. Preliminary Tests for Trouble. 19. Peculiarities of A.V.C. and Q.A.V.C. Circuits. 20. Receiver Analysis by Voltage-Current Tests. 21. Receiver Analysis by Resistance Tests. 22. Testing Individual Radio Components. 23. Obscure Troubles Not Revealed by Analyzers. 24. Aligning and Neutralizing T.R.F. Receivers. 25. Aligning and Neutralizing Superheterodyne Receivers. 26. Repairing Individual Radio Components.

Part III. 27. Installing and Servicing Auto-Radio Receivers. 28. Servicing All-Wave Receivers. 29. Installing and Servicing Marine Radio Receivers. 30. Reducing Electrical Interference. 31. High-Fidelity Receiver Problems. 32. How to Sell Your Service.

Part IV. Appendix—Vacuum Tube Charts. Index.

Of exceptional interest to the student is the careful manner in which the technical descriptions have been written with especial emphasis on particular points; and where a question would naturally arise that would not properly be explained at the moment, cross-reference is made to the chapter in which it is more fittingly considered.

MODERN ACOUSTICS, by A. H. Davis. Published by The MacMillan Co., 1934. Size 6 x 9¼ ins. 345 pages, price \$6.00.

The acoustical field has changed considerably in the past 20 years or so, so much so that a new treatment of old ideas is deemed necessary. This volume treats acoustics not so much from an angle of change in fundamental theory as in the development and introduction of electrical apparatus and methods. There are some omissions, but these are of elementary acoustics which may be found in any textbook, and which are of very little

significance in modern developments.

This volume will serve as a reference for students and technicians alike, and for all others who wish to acquaint themselves with modern acoustical methods and their applications.

APPLIED GEOPHYSICS IN THE SEARCH FOR MINERALS by A. S. Eve and D. A. Keys. Published by Cambridge University Press. Size 6 x 9 ins., 296 pages. Price \$4.25.

All those interested in applied geophysics will find a fund of useful information in this volume. It is one of the best and most comprehensive works published on the subject and will no doubt be widely referred to, yet it is written in a style that makes for easy understanding.

The discussion starts with the most fundamental "treasure locator," the diving grav, and continues through electric, seismic, gravitational and many other methods.

This work fully answers the need for an authoritative discourse on the subject.

POPULAR TELEVISION, by H. J. Barton Chapple. Published by Pitman Publishing Corp., 1935. Size 5 x 7½ ins. 144 pages. Price \$1.00.

This book is an honest endeavor to set out clearly the facts of television as they are known today. The principles are discussed, as are the various means used to obtain an image. A description is given of various modern television receivers.

The book is written in a popular vein and should do much to bring to the "potential using public" an understanding of the problems and progress of the art today.

PRACTICAL RADIO COMMUNICATION by Arthur R. Nilson and J. L. Hornung. Published by McGraw-Hill Book Co., Inc., 1935. Size, 6½ x 9 ins., 756 pages. Price, \$5.00.

A complete text on practical radio communication written by two men who are experts in their line. A full treatment of radio and electrical principles is given with considerable space devoted to alternating current principles. The requirements for all classes of radio operators' license examinations are covered. The book is of great use to any type of radio operator, broadcast, marine, police, or any other. It also can be used by the beginner as a very thorough test.

This volume is clear, concise, and very complete.

EDUCATION ON THE AIR. Edited by Josephine H. MacLatchy. Published by Ohio State University, 1934. Size 6½ x 9¼ ins., 366 pages. Price, \$3.00.

This volume is the 5th Yearbook of the Institution for Education by Radio. It is a very complete symposium on the use of radio for educational purposes. The first chapter is devoted to the more general aspects of radio broadcasting, while all others deal directly with some angle of educational radio broadcasting.

The book should be of the greatest interest to those in its field, particularly in the educational line.

MODERN RADIO ESSENTIALS, by Kenneth A. Hathaway. Published by American Technical Society, 1936. Size 6 x 8½ ins., 204 pages. Price, \$2.00.

Well adapted for use as a textbook, this compact volume thoroughly covers the field of elementary radio and its associated sciences, acoustics, magnetism and electricity. The book is very complete and covers all phases of radio, such as receivers, antennas, vacuum tubes and many others. It is an excellent treatise for any beginner in the field and yet is a handy reference for the more advanced technician.

PHOTOELECTRIC AND SELENIUM CELLS, by T. J. Fielding. Published by Instruments Publishing Co., 1935. Size 5 x 7¼ ins., 140 pages. Price \$1.75.

This book is intended to familiarize the average practical man or student with the principles underlying the operation of photoelectric cells and their applications. Much space is devoted to fundamentals and to construction and experiments with the cells. The use of photoelectric equipment in industry is also well covered.

(Continued on page 576)

Please Say That You Saw It in RADIO-CRAFT

Here's SOUND Advice!



USE ALLIED P.A. EQUIPMENT

Service men! Sound Specialists! For real money-making, customer-pleasing P.A. equipment—see your ALLIED Catalog! Get acquainted with our unbeatable line—5 to 50 watts—individual amplifiers or complete systems. Portable, mobile or permanent—pre-amplifiers, microphones, speakers, phono equipment, recording systems, etc.—Sound for every need!

FREE CONSULTING SERVICE
 Write to our Sound Engineering Division for sound, expert advice on your P.A. problems. We're ready to answer any question, to supply any type of Sound Equipment at rock-bottom prices. Write to us: only ALLIED can give you "Sound" Value, "Sound" Service, and "Sound" Prices.

SEND FOR FREE CATALOG Dept. D

ALLIED RADIO
 833 W. JACKSON BLVD.
 CHICAGO, ILLINOIS

FREE HELP For Radio Constructors

- (1)—Write for FREE CATALOG of Condensers, Transformers, Chokes, Sockets, Coils. Contains technical data on receiving and transmitting equipment.
- (2)—Attach 10c for 32-page Manual of most popular Short-Wave Receivers with illustrations, diagrams and parts lists.

Address Dept. RC-3
HAMMARLUND MANUFACTURING CO.,
 424-438 W. 33rd St., New York.



QUALITY recommends

Condensers by **SOLAR**

WET... DRY
 PAPER
 MICA... TRIMMER

Please Write for Details
SOLAR MFG. CORP. 599-601 Broadway
 New York City



UNIVERSAL Model E

Condenser Type Microphone
 Amazing quality at a sensationally low price. 90° Swivel Head with Automatic Barometric Adjustment—2-stage Amplifier—Non-Microphonic Tubes—Solid Bar grating Diaphragm Protection—Polished Aluminum and Chrome Plated—Dealers Net Cash—\$35.28.

UNIVERSAL MICROPHONE CO., Ltd.
 424 Warren Lane Inglewood, Calif., U.S.A.

RADIO ENGINEERING,

broadcasting, aviation and police radio, servicing, marine radio telegraphy and telephony, Morse telegraphy and railway accounting taught thoroughly. Engineering course of nine months' duration equivalent to three years of college radio work. All expenses low. Catalog free. School established 1874.
Dodge's Institute, Hudson St., Valparaiso, Ind.

Learn IN YOUR SPARE TIME ELECTRICITY

DIESEL ELECTRIC POWER...RADIO REFRIGERATION...AIR CONDITIONING
Practical Shop Training at Home



Electricity today offers opportunities undreamed-of a few years ago. And Electric Institute's revolutionary new plan of home shop training brings—to your very door—the practical training to qualify for the rich rewards that are waiting in the great field of Electricity.

EARN WHILE YOU LEARN

There is no need to give up your present job until you are trained for an electrical job...opportunities to make \$5, \$10 or more a week while training. No need to leave home to get this practical, thorough training. We furnish, at no extra cost, dozens of items of electrical equipment for your own home workshop...then show you how to do actual jobs. Money back if not satisfied. Mail coupon today for full details. H. W. Peterson, President ELECTRIC INSTITUTE, Inc., Dept. 156C, 5840 Addison St., Chicago, Ill.

**RUSH
COUPON FOR
FREE BOOK!**

H. W. Peterson, President
ELECTRIC INSTITUTE, Inc.
Dept. 156C, 5840 Addison St., Chicago, Ill.
Send Free Book and full details of E. I. Home Shop Training.

Name.....Age.....
Address.....
City.....State.....

(Continued from page 575)
In short the book will enable the practical man to grasp the fundamentals of the subject without going into the technical end too deeply.

SHORT-WAVE RADIO HANDBOOK by Clifford E. Denton. Published by Radio & Technical Publishing Co., 1935. Size 6 1/2 x 8 1/2 ins., 127 pages. Price, \$1.00.

The author has collected much data in the course of several years' experimentation; these data form the basis for this book. It is of the practical type, mathematics having been left out in most cases since it was believed the average fan is interested mainly in results.

A small amount of theory is included and the book is illustrated by a great many line drawings and photos, as well as many useful tables. The experimenter will find this handbook of great help in his work.

ELECTRICAL MEASUREMENTS by H. Cobden Turner. Published by Instruments Publishing Co., 1935. Size 6 x 8 1/2 ins., 354 pages. Price \$4.50.

The data contained in this book are of a practical nature and deal mainly with the tests which are most frequently made. It was written for the man who only occasionally makes an electrical test and for this reason, some data on important tests which are made only rarely, have been omitted. There is very little mathematical theory involved, but the subject matter will nevertheless be of interest to the more advanced technician.

The fact that mathematical proofs have been for the most part eliminated, makes it possible to include many additional types of measurements, such as those of speed, temperature, light and others less well known.

SOS TO THE RESCUE by Karl Baarslag. Published by the Oxford University Press, 1935. Size 6 x 8 1/2 ins., 310 pages. Price \$2.50.

While this is purely a book of fiction, it is an absorbing narrative of the history and development of the use of radio in rescue work at sea. Many facts never before published are given here, and, so absorbing is the sequence, that the reader will not care to leave the book, once it has been started. There are many references to technical equipment, but these in no way spoil the story for the layman.

This is an outstanding tribute to "Sparks," written by one who has been through the mill.

FERNSEH EMPFANG by Manfred von Ardenne. Published by Weidmannsche Buchhandlung. Size 6 x 8 1/2 ins., 117 pages. Price, about \$3.50.

Television reception by means of the cathode ray tube, the system perfected by the author, is completely covered in this interesting book. There is a wealth of information not only on the theoretical aspects of this subject, but much data on the actual construction of such equipment.

This work is highly recommended to those who read German, as an authoritative treatise on television as accomplished with cathode ray tubes.

ELECTRON TUBES IN INDUSTRY by Keith Henney. Published by McGraw-Hill Book Co., 1935. Size, 6 x 9 ins., 490 pages. Price, \$5.00.

The use of electron tubes in speeding up and cheapening manufacturing processes is thoroughly covered in this volume. It tells not only what is being done, but how it is accomplished. All the tubes useful in industrial operations are described. The rapid expansion of this field makes this book particularly useful at this time. Comparisons between tubes and other corresponding systems are given, with an unbiased description of the features of each.

RADIO DATA CHARTS by R. T. Beatty. Published by Illiffo and Sons, Ltd., 1935. Size 8 1/2 x 11 ins. Price, \$1.20.

This set of data charts published in England is very handy for those who do not like to do mathematics or who wish to save time when working out radio problems. By the use of the charts and a ruler, many tedious problems may be instantly solved.

Each "Abac," as the charts are called, has complete data on its use, enabling the experimenter to obtain the greatest possible use from it.

The field covered is very broad, and includes all manner of R.F., A.F., and every other conceivable type of "Abac" which would be of use to the experimenter.

Index to Advertisers

A	
Alloy Transformer Co., Inc.	560
Aerovox Corporation	556
Allied Radio Corporation	566, 568, 575
Arrow Sales Corporation	550
B	
Bian the Radio Man, Inc.	571
C	
Capitol Radio Engineering Instit.	567
Central Radio Laboratories	531
Classified Section	571
Cough-Brengle Co.	561
Coast-to-Coast Radio Corp.	564
Commercial Laboratories	566
Cornell-Dubilier Corp.	566
Coyne Electrical School	513
D	
Dodge's Institute	575
E	
Electrad, Inc.	562
Electro Institute	576
F	
Freed Radio Company	568
G	
General Cement Mfg. Co.	568
General Electric Company	Back Cover
General Transformer Corp.	555
Goldentone Radio Company	568
Greenback Company	571, 573
H	
Hammachand Mfg. Company	575
Hygrade-Sylvania Corp.	557
I	
Insuline Corp. of America	564
International Resistance Co.	559
L	
Lincoln Engineering School	568
Arthur H. Lynch, Inc.	560
M	
McGraw-Hill Book Co.	552
Midwest Radio Corp.	Inside Back Cover
Million Radio & Television Labs.	554
N	
National Radio Institute	515
National Union Radio Corp.	564
New York YMCA Schools	561
O	
Oxford-Tartack Radio Co.	563
P	
Philo Radio & Television Corp.	551
R. L. Polk and Company	564
Popular Book Corp.	572
Precision Apparatus Corp.	567
R	
Radio & Technical Pub. Co.	556
Radio & Television Institute	565
Radio Circular Company	554
Radio City Products Co.	550
Radio Constructors Labs.	566
Radio Manufacturers Service	551
Radio Publications	572
Radio Trading Company	560
Radio Training Assoc. of America	573
Radolek Company	576
Raytheon Production Corp.	563
RCA Mfg. Company, Inc.	573
Readrite Meter Works	569
Remington Rand, Inc.	564
S	
S. O. S. Corporation	568
Schooley Engineering Co.	568
Sears, Roebuck & Company	571
Shallcross Mfg. Corp.	562
Short Wave Listener	571
Solar Mfg. Company	575
F. L. Sprayberry	560
Sprayberry Academy of Radio	555
Standard Transformer Corp.	563
Supreme Instruments Corp.	Inside Front Cover
T	
Teleplex Company	559
Thor Radio Company	567
The Trailer Plan Shop	564
Trinkett Electrical Instr. Co.	553
U	
Universal Microphone Co.	575
W	
Wellworth Trading Co.	552, 569, 570
Wholesale Radio Service Co., Inc.	558
Wright-DeCoster, Inc.	558
Z	
Zephyr Radio Company	563

(While every precaution is taken to insure accuracy, we cannot guarantee against the possibility of an occasional change or omission in the preparation of this index.)



Just
off the
Press!

Completely Revised!

The New Radolek 1936 Profit Guide is the most complete Radio Parts Catalog ever published. Completely revised—right up to the minute, bringing you everything in Radio—at the right prices. Packed with valuable money-saving "radio-buying" information—every page brings you extra profits! Contains over 10,000 individual Repair Parts—hundreds of new items—a complete new selection of Receivers and Amplifiers. Radolek offers you one complete source for all your Radio requirements. Everything you need—always in stock—ready for prompt delivery to you. This Book is your handy index to Radolek's huge storehouse of Radio materials you need it—it's FREE! Send for it!

RADOLEK restricts distribution of the PROFIT GUIDE to those outlets and commercially engaged in the Radio Business. Please enclose your Business Card or Letter Head.



RADOLEK

571 W. Randolph Street,
Chicago, Illinois

Name.....

Address.....

Service man? Dealer? Exper?

Please Say That You Saw It in RADIO-CRAFT

KABLE BROS. CO., PRINTERS

QUALITY INSIDE AS WELL AS OUTSIDE... *That's the Secret of Midwest's Leadership*

Only Radio with Six Wave Bands
Covering **4½ to 2,400 METERS!**

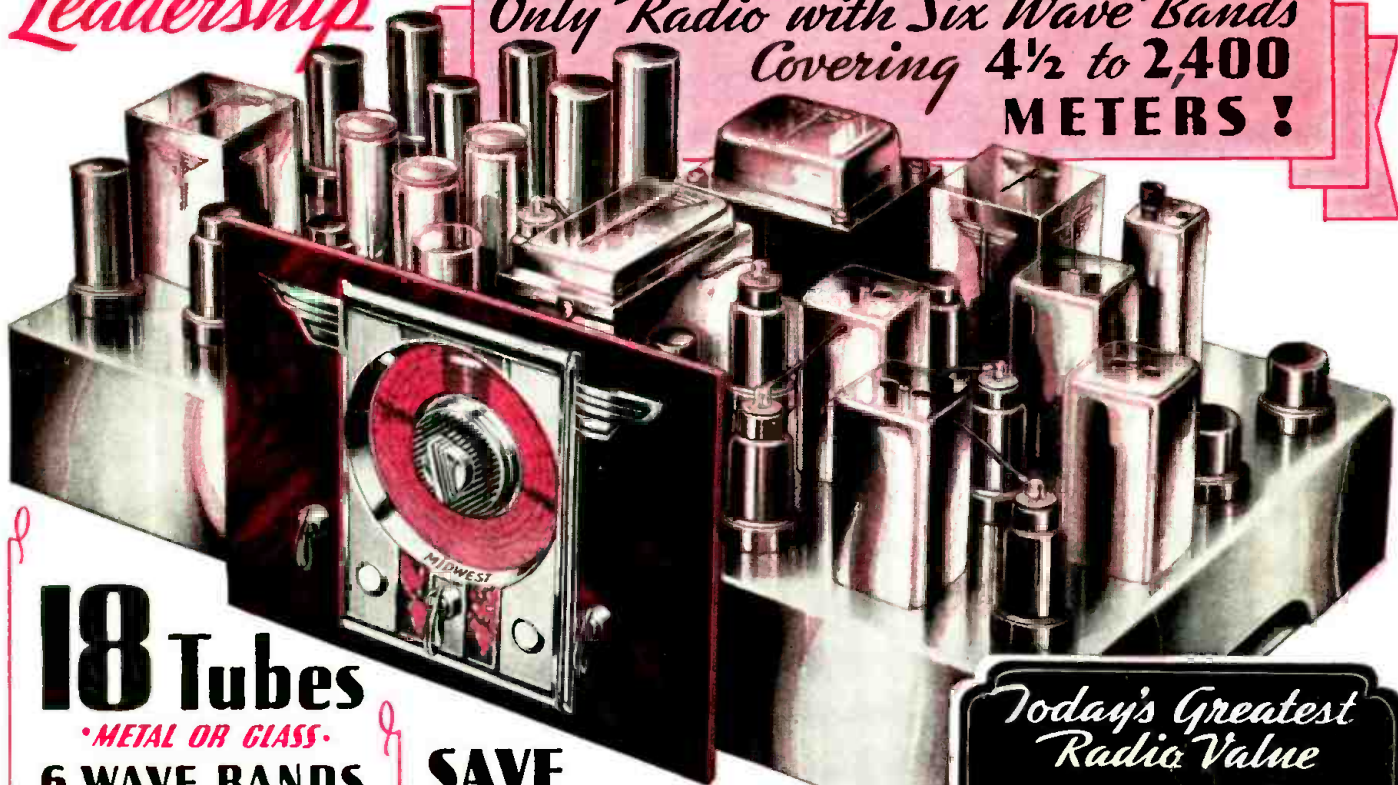

18 Tubes

METAL OR GLASS

6 WAVE BANDS

80 Advanced Features

18 Tubes and 6 wave bands are but two of the 80 advanced features that include every worthwhile advantage, that even the most critical radio technician and enthusiast could ask for. Some of the other exclusive features are: Station Finder Button, enabling "hams" to secure CW—Silencer Button, which silences the set between stations—38 Tuned Circuits give Maximum Selectivity—4 Gang Condensers—Reinforced Capacitors and Pre-aged Intermediate Frequency Transformers prevent drift, etc. The balance of the 80 features are described in detail on pages 12 to 21 inclusive, of the new FREE 40-page catalog.

Before you buy any radio, write for the free 40-page 1936 catalog, and learn about the successful Midwest Laboratory - To - You policy that saves you 30% to 50%, that gives you 30 days free trial in your own home. No middlemen's profits to pay. You buy at wholesale price, direct from Laboratories... making your radio dollar go twice as far. You can order your 1936 Midwest radio from the new 40-page catalog with as much certainty of satisfaction as if you were to come yourself to our great laboratories.



SAVE

UP TO **50%** *Direct from Midwest Laboratories.*

ONCE again, Midwest demonstrates its leadership by offering the world's most powerful super deluxe 6-tuning range radio. It is a master achievement...today's most highly perfected, precisely built, laboratory tested unit. It is a radio-musical instrument that will thrill you with its marvelous super performance...glorious new acousti-tone...crystal-clear "concert" realism...and magnificent foreign reception.

Only Midwest Gives 6 Tuning Ranges (4½ to 2400 Meters)

Midwest is the only radio in the world that positively covers every possible and useful wave band. Accurately made, precisely assembled, rigidly tested, this 18-tube Super De Luxe radio assures the brilliant super performance that radio "hams" and enthusiasts demand. The 18 tubes permit of advanced circuits making it possible to use the tremendous reserve power, and to exert the sustained maximum output of the powerful new tubes. These sets are vibration tested, many times, until "creeping screws" and other means of adjustment are locked permanently in position. It is interesting to note that this is the only home receiver that is "aged." All shrinkage and drift are completely eliminated by the use of such features as reinforced capacitors, pre-aged intermediate frequency transformers, as well as elaborate pre-aging tests and processes.

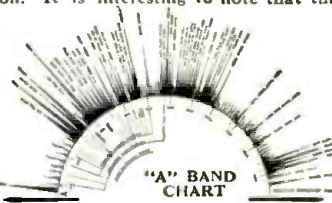

Today's Greatest Radio Value
\$77.45
COMPLETE with 18 Tubes and GIANT THEATRE-SONIC SPEAKER

TERMS AS LOW AS \$5.00 DOWN

The Midwest "A" band chart, illustrated at left, shows how the perfect reception of the Midwest equalizes the widely varying powers assigned to those fortunate stations enjoying cleared channel and semi-cleared channel broadcasting. These stations come in clearly and with equal volume. The short wavering lines indicate that many stations are operating on the same wavelength. These stations are useful only when one of them is located close to your set. Charts, illustrating the stations that can be secured on the five additional bands, are pictured on pages 20 and 21 of the Midwest catalog. You save 30% to 50%... you get 30 days FREE trial... as little as \$5.00 down puts a Midwest radio in your home. You are triply protected with a One-Year Guarantee, Foreign Reception Guarantee and Money-Back Guarantee. Write for FREE 1936 catalog. See for yourself that this super radio will out-perform sets costing two and three times as much.

MAIL COUPON TODAY for FREE 30-DAY TRIAL OFFER and 40-PAGE FOUR COLOR CATALOG

MIDWEST RADIO CORPORATION, Dept. 12R, Cincinnati, Ohio.

Without obligation on my part, send me your new FREE catalog, complete details of your liberal 30-day FREE trial offer, and FREE Miniature Rotating 18-tube Dial. This is NOT an order.

Name _____
Address _____
Town _____ State _____
Check if interested in a Midwest All-Wave Battery Radio

User-Agents Make Easy Extra Money
Check Here for details

EXPRESSLY DESIGNED FOR
STABILIZED PERFORMANCE

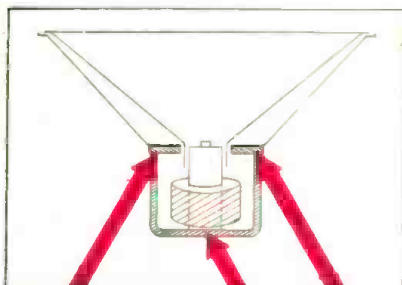

A new G-E process — projection welding — results in a permanent and perfect magnetic path.



Projection welding also prevents misalignment of center post — a source of many speaker noises.

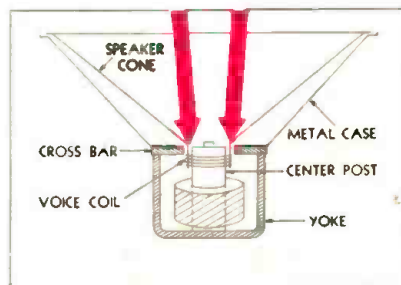

A perfect magnetic path and permanent alignment give crystal-clear tone and stabilized performance.

MODEL A-82
 8 metal tubes, four reception bands 140-410
 k.c. and 540-19,500 k.c.

\$94.60 (Eastern List Price)



The Stabilized Dynamic Speaker is but one of five major features which contribute to stability in the life and performance of General Electric receivers.

ADDITIONAL FEATURES ARE:

Metal Tubes—Strong and clear in signal. Supremely quiet—especially on short-wave broadcasts.

Sentry Box — Controls as many as five separate broadcast bands — permitting only one radio wave to pass.

Permaliners — Maintain the original factory adjustment of the set. Sealed against moisture and dirt.

Sliding-rule Tuning Scale—Shows only one tuning scale at a time—lists all stations in a straight line. As easy to read as a ruler.

GENERAL  ELECTRIC

The Original Metal-tube Radio

APPLIANCE AND MERCHANDISE DEPARTMENT, GENERAL ELECTRIC COMPANY, BRIDGEPORT, CONN.